



**Fitting type:** Inset

**Sink handing:** Reversible

**Finish style:** Top brushed

- **Min. base unit (bowl, tap & overflow only):** 600 mm
- **Packaged size L x W x D:** 925 x 590 x 270mm
- **Supplied boxed or sleeved:** Boxed
- **Boxed weight:** 7.50 kg
- **Sink only weight:** 3.80 kg

- Durable 18/10 stainless steel construction throughout
- One a half bowl design for maximum practicality
- Reversible drainer position for maximum flexibility
- Easy clean bowl curves
- Prefitted worktop seal

**Included parts:**



2 x AX1005 (m)  
90mm (1.5") Basic manual basket  
strainer waste - short bolt



1 x AX1006 (m)  
Rectangular overflow pipework



1 x AX1009 (m)  
1.5 or 2.0 Bowl pipework



1 x AX4000 (m)  
Fitting & care instructions & data sheet  
- st/st inset



1 x AX1019 (m)  
Inset self adhesive foam sealing strip,  
3.0 meters



AX1014 (m)  
35mm tap hole cover plate - brushed  
steel



1 x AX1062 (m)  
Long reach steel fixing clips x 10

**Recommended accessories:**

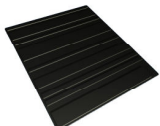

1 x AX2501  
Silicone drainer mat 330 x 390mm

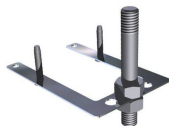

1 x AX1011  
Tap stabilising bracket



1 x AX3008  
Bowl mat 246 x 302 R37

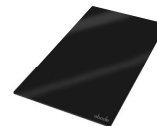

1 x AX2014  
Glass Chopping Board 500x280mm  
(450) - Black Gloss

All accessories can be purchased directly from [www.abode-shop.co.uk](http://www.abode-shop.co.uk) or phone 01226 283434

**Materials and workmanship warranty summary:**

- Sink materials & workmanship 10 years.
- Waste kits 1 year.
- Connecting pipework 1 year.

**Care instructions:**

- Clean the products regularly using soapy water and a non abrasive cloth, regular cleaning will prevent the build up of lime scale and dirt.
- Avoid contact with corrosive or abrasive substances.
- After cleaning rinse thoroughly with clean water then dry.
- For more detail see supplied booklet or [www.abodedesigns.co.uk](http://www.abodedesigns.co.uk)

**Product dimensions and installation information:** note:



symbol indicates position of acoustic pad on stainless products.

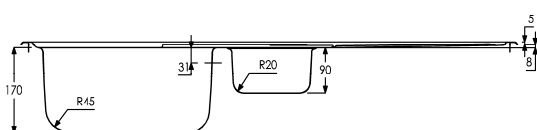
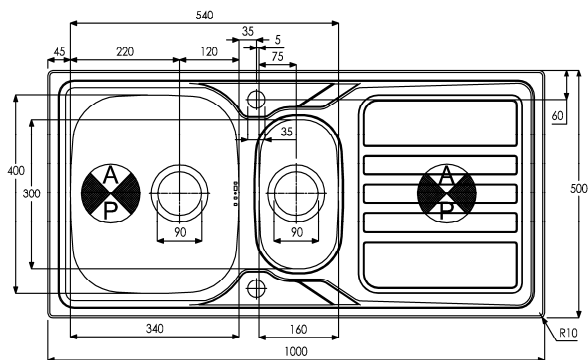

**INSET CUT OUT**

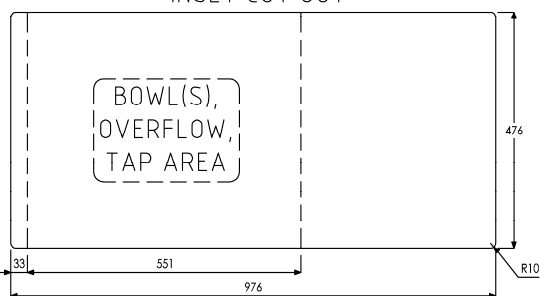

**Additional notes:**

**Overall product size:** 1000 x 500 x 187 corner radius 10mm

**Tap hole(s) detail:** 2 x Ø 35mm, pre-cut

**Compatibility with large square taps:** Please check compatibility of some large square base design taps with this sink

**Wastehole(s) detail (mm):** 90 / 90 / N/A (nb. 90mm wastes accept a waste disposal unit)

**Min. base unit (refers to space required for bowl, tap and overflow only):** fits 600mm carcass

**Min. Recessed fitting width:** required (bowl(s), tap and overflow): 551 mm

**\*Worktop cut out size:** 976x476 corner radius 10mm, for .DXF cut files please see [www.abode.eu](http://www.abode.eu)

**Min. & Max worktop depth or clip depth reach range:** 25 - 45mm

**Fitting temple supplied?** No, use cut out instructions as supplied

**Dishwasher under drainer?** Distance from top of worktop to underside of the drainer 8mm



**\*Important, fabricator / installer notes for undermount & flushmount sinks:**

The cut out size indicated is aligned with outside edge of the bowl top radius (see example below).

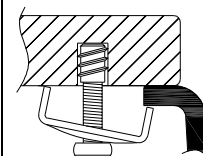

You should confirm with your client if the worksurface cutout is to be cut flush, inside or outside this suggested perimeter shape & size.

If you create the cutout smaller or larger than the indicated size then the fit of the accessories may be affected and should be physically checked.

**General:**

All details are provided in good faith but do not include the tolerances of the material or manufacturing process.

**We request that a test cutout is made in scrap timber and checked against the actual sink to be installed before committing to cutting the final worksurface.**

**Abode can not accept liability for problems or costs incurred by failure to follow this request.**

Note: the dimensions on ceramic fireclay products are subject to wider tolerances due to the nature of this natural material and the firing process.

CAD cutout files can be downloaded from [www.abodedesigns.co.uk](http://www.abodedesigns.co.uk)

**Bowl details:** (sizes in mm unless specified otherwise)

**Bowl 1 (typically main bowl):**

**Bowl 1 size L x W x D (mm):** 340 x 400 x 170

**Bowl 1 construction:** Pressed, 0.70mm

**Bowl 1 floor radius (mm):** 45

**Bowl 1 Wastehole diameter (mm):** 90

**Bowl 1 overflow:** Slotted, barcode pattern

**Bowl 1 texture:** Unbrushed / satin

**Bowl 1 apx. volume (litres):** 13.70

**Bowl 2 (typically 1/2 or 3/4 bowl):**

**Bowl 2 size L x W x D (mm):** 160 x 300 x 90

**Bowl 2 construction:** Pressed, 0.70mm

**Bowl 2 floor radius (mm):** 20

**Bowl 2 Wastehole diameter (mm):** 90

**Bowl 2 overflow:** N/A

**Bowl 2 texture:** Unbrushed / satin

**Bowl 2 apx. volume (litres):** 3.90

**Bowl 3:**

**Bowl 3 size L x W x D (mm):** N/A x N/A x N/A

**Bowl 3 construction:** N/A, N/Amm

**Bowl 3 floor radius (mm):** N/A

**Bowl 3 Wastehole diameter (mm):** N/A

**Bowl 3 overflow:** N/A

**Bowl 3 texture:** N/A

**Bowl 3 apx. volume (litres):** N/A