



Fitting type: Inset

Sink handing: Right hand drainer

Finish style: Brushed steel

- **Min. base unit (bowl, tap & overflow only):** 500 mm
- **Packaged size L x W x D:** 1020 x 610 x 305mm
- **Supplied boxed or sleeved:** Boxed
- **Boxed weight:** 10.44 kg
- **Sink only weight:** 3.86 kg

- Durable 18/10 stainless steel construction throughout
- Practical and durable glass covers add minimalist style
- The very latest word in modern style
- Smooth lined luxury Orbit waste supplied as standard
- Deep bowl(s) to accept larger cookware

Included parts:



1 x AX1001 (m)
90mm (1.5") Orbit manual basket
strainer waste - short bolt



1 x AX1006 (m)
Rectangular overflow pipework



1 x AX1008 (m)
1.0 Bowl pipework



1 x AX4005 (m)
Fitting & care instructions & data sheet
- st/st inset extension tie rod



8 x AX1021 (m)
Rotating fixing clip



5 x AX1022 (m)
Fixing clip bridge



4 x AX1034 (m)
Wall mounted fixing clip



4 x AX1035 (m)
Extension tie rod



1 x AX1011 (m)
Tap stabilising bracket

Recommended accessories:

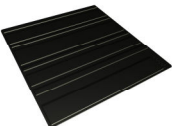

1 x AX2500
Silicone drainer mat 320 x 320mm

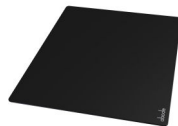

2 x AX2000
1 x Sink Cover 447x407mm (405) -
Black Gloss



2 x AX2001
1 x Sink Cover 447x407mm (405) -
White Gloss

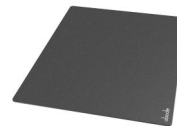

2 x AX2002
1 x Sink Cover 447x407mm (405) -
Silver



1 x AX3003
Bowl mat 325 x 265 R40



1 x AX2502 or AX2503
High & Dry drainer rack - Green &
grey or White & grey

All accessories can be
purchased directly from
www.abode-shop.co.uk
or phone 01226 283434

Materials and workmanship warranty summary:

- Sink materials & workmanship 10 years.
- Waste kits 1 year.
- Connecting pipework 1 year.

Care instructions:

- Clean the products regularly using soapy water and a non abrasive cloth, regular cleaning will prevent the build up of lime scale and dirt.
- Avoid contact with corrosive or abrasive substances.
- After cleaning rinse thoroughly with clean water then dry.
- For more detail see supplied booklet or www.abodedesigns.co.uk

Product dimensions and installation information: note:



symbol indicates position of acoustic pad on stainless products.

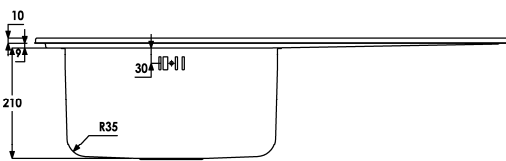
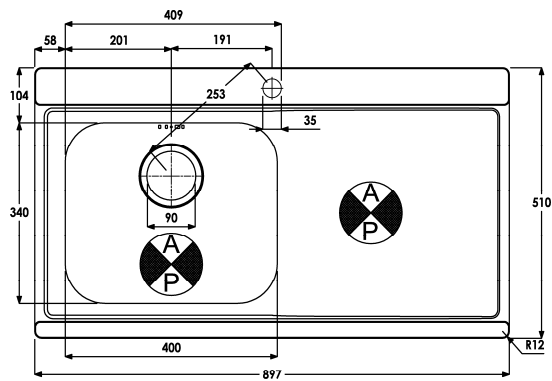

INSET CUT OUT

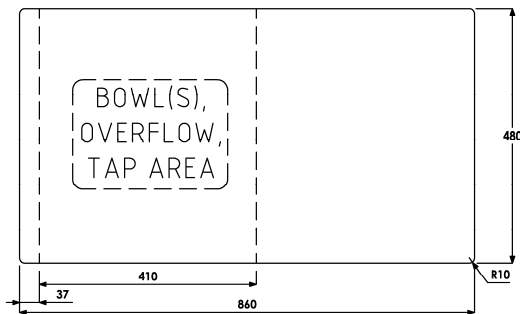

Additional notes:

Overall product size: 897 x 510 x 234 corner radius 12mm

Taphole(s) detail: 1 x Ø 35mm, pre-cut

Compatibility with large square taps: No known incompatibilities

Wastehole(s) detail (mm): 90 / N/A / N/A (nb. 90mm wastes accept a waste disposal unit)

Min. base unit (refers to space required for bowl, tap and overflow only): fits 500mm carcass

Min. Recessed fitting width: required (bowl(s), tap and overflow): 410mm

***Worktop cut out size:** 860x480 corner radius 10mm, for .DXF cut files please see www.abode.eu

Min. & Max worktop depth or clip depth reach range: 25 - 40mm

Fitting template supplied? No, use cut out instructions as supplied

Dishwasher under drainer? Distance from top of worktop to underside of the drainer 9mm



***Important, fabricator / installer notes for undermount & flushmount sinks:**

The cut out size indicated is aligned with outside edge of the bowl top radius (see example below).

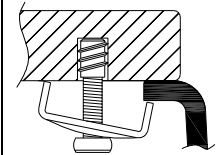

You should confirm with your client if the worksurface cutout is to be cut flush, inside or outside this suggested perimeter shape & size.

If you create the cutout smaller or larger than the indicated size then the fit of the accessories may be affected and should be physically checked.

General:

All details are provided in good faith but do not include the tolerances of the material or manufacturing process.

We request that a test cutout is made in scrap timber and checked against the actual sink to be installed before committing to cutting the final worksurface.

Abode can not accept liability for problems or costs incurred by failure to follow this request.

Note: the dimensions on ceramic fireclay products are subject to wider tolerances due to the nature of this natural material and the firing process.

CAD cutout files can be downloaded from www.abodedesigns.co.uk

Bowl details: (sizes in mm unless specified otherwise)

Bowl 1 (typically main bowl):

Bowl 1 size L x W x D (mm): 400 x 340 x 210

Bowl 1 construction: Pressed, 0.70mm

Bowl 1 floor radius (mm): 35

Bowl 1 Wastehole diameter (mm): 90

Bowl 1 overflow: Slotted, barcode pattern

Bowl 1 texture: Brushed stainless

Bowl 1 apx. volume (litres): 22.40

Bowl 2 (typically 1/2 or 3/4 bowl):

Bowl 2 size L x W x D (mm): N/A x N/A x N/A

Bowl 2 construction: N/A, N/Amm

Bowl 2 floor radius (mm): N/A

Bowl 2 Wastehole diameter (mm): N/A

Bowl 2 overflow: N/A

Bowl 2 texture: N/A

Bowl 2 apx. volume (litres): N/A

Bowl 3:

Bowl 3 size L x W x D (mm): N/A x N/A x N/A

Bowl 3 construction: N/A, N/Amm

Bowl 3 floor radius (mm): N/A

Bowl 3 Wastehole diameter (mm): N/A

Bowl 3 overflow: N/A

Bowl 3 texture: N/A

Bowl 3 apx. volume (litres): N/A