



Product features:

- Metal construction throughout
- Rub clean anti limescale spray nozzles
- Single spray pattern showerhead
- Elegant minimalist design styling with a softened edge
- Swivel showerhead connector for maximum flexibility

Packaged properties:

Box length (mm): 365 Box depth(mm): 80
Box width(mm): 230 Boxed weight (Kg): 1.7

Includes pop up waste?: No

Additional comments:
9 litre limiter included

Product dimensions:

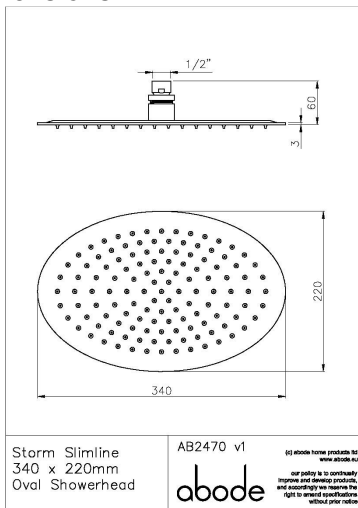

- **Product mounted where:** Roof / wall
- **Recommended hole size:** N/A mm
- **Overall Height / projection:** 60 mm
- **Exit reach:** N/A mm
- **Exit height:** 60 mm
- **Base size:** n/a mm
- **Inlet centre distance(s):** N/A mm
- **Min. fitting depth required:** n/a mm
- **Max. surface depth:** n/a mm

Product flow characteristics:

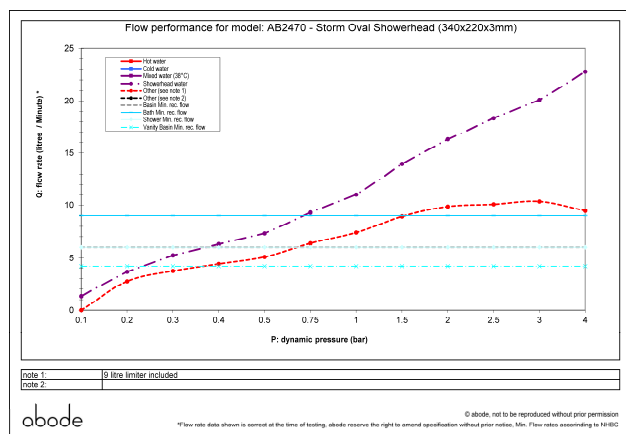

- **Min / Max water pressure (bar):** 0.40* / 5.50
- **Part G max. mixed flow rate at 3 bar (l/m):** 20.09
- **Inlet connection type / length:** Fixed / N/A mm
- **Inlet (plumbing connection) / outlet size:** 1/2" F / M32 X 1.5
- **Product flow characteristics:** N/A
- **Non return valve(s) supplied or position:** no
- **Aerator type:** Clear silicone rub clean nozzles
- **Control valve type:** N/A (N/A)
- **Includes output diverter?:** N/A
- **Inlet meshed particle filters included:** 0.60 mm
- **Shower hose type / length:** N/A / N/A

Warranty Summary (full details available on request):

- Materials and workmanship defects warranted for 5 years
- Valves and working parts warranted for 5 years
- Surface warranty defects warranted for 1 year
- O-rings, hoses & gaskets warranted for 1 year

Care instructions:

- Clean the mixers and showers regularly as required, using soap, do not use any other cleaners.
- Regular cleaning will prevent the build up of lime scale and dirt
- After cleaning rinse thoroughly with clean water to remove any cleaner residue
- Residues of liquid soaps, shampoos and shower foams can also cause damage, so rinse with clean water after using, avoid contact with any abrasives