

Product features:

- Luscious European quality chromium plate finish
- Rub clean anti limescale spray nozzles
- Single spray pattern showerhead
- Elegant minimalist design styling with a softened edge
- Swivel showerhead connector for maximum flexibility



Packaged properties:

Box length: 330 mm **Box depth:** 75 mm
Box width: 315 mm **Boxed weight:** 2.54 kg

Includes pop up waste?: No

Additional comments:
 1.5mm allen key , 2 x grub screw

Product dimensions:

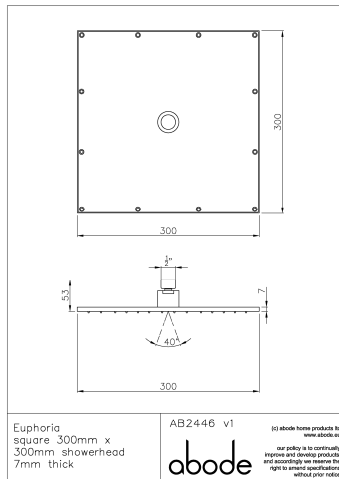

- **Overall Height / projection:** 53 mm
- **Exit reach:** N/A mm
- **Exit height:** 53 mm
- **Centre distance(s):** N/A mm
- **Base diameter(s):** N/A mm
- **Product mounted where:** Roof / wall
- **Recommended hole diameter:** N/A mm
- **Min. fitting depth required:** N/A mm
- **Max. surface depth:** N/A mm

Product flow characteristics:

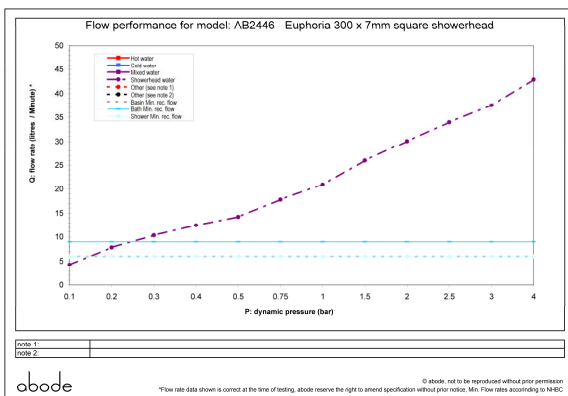

- **Min / Max water pressure:** 0.2 / 5 bar
- **Part G mixed flow rate at 3 bar (l/m):** 37.53
- **Max water temperature:** 70° C
- **Product flow characteristics:** N/A
- **Aerator type:** Clear silicone rub clean nozzles
- **Includes output diverter?:** No
- **Control valve type:** N/A (N/A)
- **Non return valve position:** No
- **Mesh particle filter size:** 0.60 mm
- **Inlet / outlet size:** 1/2" F / TBC
- **Inlet type / length:** Fixed / N/A mm
- **Shower hose type / length:** N/A / N/A

Warranty Summary (Full details available on request):

- Materials and workmanship defects warranted for 5 years
- Valves and working parts warranted for 5 years
- Surface warranty defects warranted for 1 year
- O-rings, hoses & gaskets warranted for 1 year

Care instructions:

- Clean the mixers and showers regularly as required, using soap, do not use any other cleaners.
- Regular cleaning will prevent the build up of lime scale and dirt
- After cleaning rinse thoroughly with clean water to remove any cleaner residue
- Residues of liquid soaps, shampoos and shower foams can also cause damage, so rinse with clean water after using, avoid contact with any abrasives