

Important Technical Data

Whilst every effort has been made to make these instructions comprehensive they may not be exhaustive, and we strongly recommend that this product is installed by a skilled professional. This will ensure the best possible finished installation.

This product is made from 304 grade '18/10' stainless steel for the greatest possible durability, after the end of the lifecycle of this product it should be recycled responsibly.

Earth bonding: under current IEE regulations there is no statutory requirement to earth bond sinks as most new wiring installations are protected with an RCD. If you are unsure whether your wiring is protected by an RCD, contact a qualified electrician.

Maximum temperature 300°C* Note: If this temperature is exceeded, even for short periods, damage to the finish can result.

Waste disposers should be mounted in such a way that the weight of the unit is supported by the kitchen cabinet carcass, not just the sink. Faulty or damaged waste disposal units can cause vibration – this will damage the sink and can loosen connecting pipework or fixings causing water leaks.

All Abode products are designed in accordance with recognised European or global standards. Please ensure that your Abode product is fitted in accordance with localised legislation.

The installation should be periodically checked for damage to water sealing parts as described in the instructions to avoid accidental water damage.

Abode is a registered trademark of Abode. All errors and omissions excepted.

A full technical specification and copies of these instructions are available for this product on our website. www.abodedesigns.co.uk

Manufacturers Product Reference

CE

Norcros Group (Holdings) Ltd
Ladyfield House
Station Road,
Wilmslow
Cheshire
SK9 1BU

Production year: See label

Abode DoP

Product code: See label

Preparation of food, washing of
dishes and discharge of
domestic wastewater.

EN 13310

CA - DA

©Abode
AX4000 v3 - 10/2016

abode

Unit L, Zenith Park, Whaley Road, Barnsley, S75 1HT.
Tel: 01226 283434 Fax: 01226 282434

www.abodedesigns.co.uk

All errors and omissions excepted.

Stainless Steel Inset Sink



10 Year Warranty Terms and Conditions

In the unlikely event that you should experience any defect in the materials or workmanship of your new Abode sink within 10 years of purchase, the manufacturer will repair or replace all or any part of the product that is defective, at their discretion. The manufacturer will not be responsible for any other consequential costs such as labour, removal or reinstallation of the sink or any other connected or related products.

This is provided that the product has been used for normal domestic purposes in the UK & Eire, and that the care, installation and maintenance instructions have been observed. The warranty extends to the original purchaser only. You should retain a copy of your dated invoice as proof of purchase to validate any claims under this guarantee.

Please note that this product is manufactured using natural materials so slight shade variations can occur. Marks, scuffs and scratches caused during installation or accidental damage are not covered by this guarantee.

Care Instructions for your Kitchen Sink

To maintain the appearance of this product, ensure that it is regularly cleaned using only a clean, soft damp cloth. A solution of warm water and a mild liquid non-antibacterial detergent may be used where necessary, and then the product rinsed thoroughly and wiped dry. Any other cleaning action will invalidate your warranty.

No household or industrial chemicals should come into contact with this product to prevent damage.

No metallic objects should be left in contact with this sink as they may cause corrosion by close contact. Prolonged exposure to acidic or alcoholic drinks or foodstuffs may also cause corrosion.

Do not cut, slice or chop directly onto the sink as this mark the surface finish. Avoid the use of plastic washing up bowls, engrained grit on the bowl underside may mark the surface finish. Avoid impacting the product with sharp or heavy objects such as knives, pans or cooking pots and also avoid contact with abrasives.

For further care and maintenance advice on removing stubborn marks and more examples of objects or actions likely to artificially shorten the life of this product, please visit our website.

Please retain these instructions with the sink for future reference

Please retain these instructions with the sink for future reference

Parts and Contents

Key	Description	Qty
A	Sink (may differ from model shown)	1
B	Fixing clips for installation	See included specification sheet
C	Tap hole blanking plate	1 (reversible sinks only)
D	Overflow, wastes and pipework	See included specification sheet
E	Care instructions and cut out sizes	1 (dependant on model)

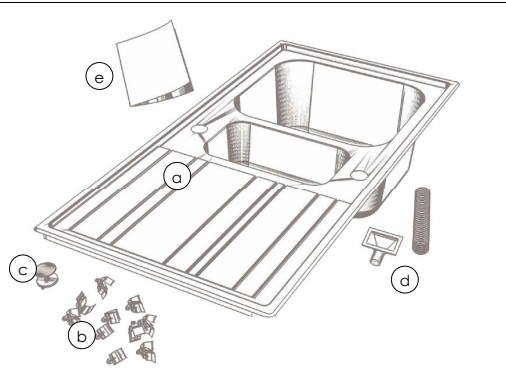

Installation Instructions

Preparation

1. Take great care when handling this sink. Whilst every effort has been taken to remove sharp edges, the material by nature may be sharp. We recommend wearing gloves accordingly. Do not lift the product by the waste hole(s) or tap hole(s).
2. Check the package for completeness and any transport damage before installation commences.
3. Check that the supporting carcasses and worktop is level left to right and front to back to ensure correct drainage of water.
4. Check that the surrounding furniture is the correct size and shape to accept this product and that no plumbing or wiring may foul the installation.
5. If fitting a tall or heavy tap to a stainless steel sink you may wish to specify a tap stabilising bracket to reduce movement of the tap. (See www.abode.eu or specification sheet for details)
6. If replacing an existing sink, remove this product and clean the surrounding area, ensure the new sink will suit the existing cut out size and position.
7. Collect the tools you will need to complete this installation. Typically this might include a spirit level, pencil, straight edge, jigsaw, Stanley knife, crosshead screwdriver and small adjustable spanner.

Installation

1. Before creating the cut out in the worktop, carefully plan the positioning of the sink. Ensure that the position of the bowl(s), tap and overflows will not interfere with surrounding units or appliances. The cut out details are published on the included specification sheet and on www.abode.eu to ensure perfect positioning of this product. Check that the fixing clips will not foul carcass walls or supporting braces.
2. Carefully mark out the cut out using the cut out drawing provided. Create the sink cut out in the worktop using a router or jigsaw following the manufacturers instructions take care not to chip, crack or scratch the worktop. When preparing the cut out cover any open pipework to avoid any debris contaminating the water supply feeds.
3. Seal the cut edges of the worktop with a waterproof sealant to prevent any possible water damage to the worktop. Ensure all exposed cuts on the worktop are correctly sealed.
4. If the sink is a reversible design choose the orientation of the bowl(s) and drainer.
5. Install the tap to the sink according to the manufacturer's instructions.
6. If required install the tap hole blanking plug. If needed this will be supplied in the fixing kit pack.

7. Install the basket strainer waste kit(s) according to the manufacturer's instructions.
8. Install the overflow(s) according to the manufacturer's instructions.
9. Check that the pre-fitted worktop seal has not been damaged in transit and covers the full perimeter of the sink (fig 1.)

10. Push the fixing clips perpendicular to the clip rail or lugs onto the underside of the sink rim (fig. 2). Whilst pushing the fixing clip to the rail rotate the fixing clip to attach it to the notches on the clip rail (fig 2).

11. Unscrew the fixing clip screws fully then rotate the hook section of the fixing clips away from the sink edge (fig. 3), this will clear the clips of the cut out when fitting the sink.

12. Pass the sink through the worktop cut out from above, align the sink straight to the cut out hole and worktop front edge (fig 4.).

13. Fix the sink to the worktop by tightening the screws on the fixing clips clockwise (fig. 5) using a crosshead screwdriver, the sink frame will pull down tight and flat to the top surface to the worktop.

Tighten the clips in an order similar to fig. 6 to ensure the sink does not skew or rotate whilst it is fixed. Do not use an electric screwdriver, this will over tighten the screws and could damage the clips.

14. Attach the sink connecting pipework to the waste kit(s) according to the manufacturer's instructions.

15. You may choose to neatly seal around the sink outer perimeter using silicone. Whilst the foam seal should provide a watertight seal we recommend this step out of prudence.

After installation

1. If the sink has a protective plastic film coating this should be removed now.
2. Clean the sink using the attached care advice ready for use.
3. Check the sink is flat to the worktop, straight and level; pour a small amount of water onto the drainer to check for drainage.
4. Close the plug(s) in all bowls fill the sink with water below the overflow, check the water does not leak through or around the waste(s).
5. Close the plug(s) in all bowls fill the sink with water above the overflow, check the water exits through the overflow and does not leak from the overflow system.
6. Open the plug(s) and let water drain from the bowls, check the connecting pipework does not leak.
7. If the sink is not to be used for a period after installation, cover the sink and tap to protect them from accidental damage during further surrounding installation work.
8. We recommend that any water seals on this sink should be checked for water tightness periodically.

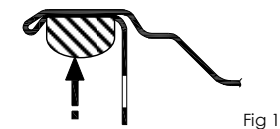

Fig 1.

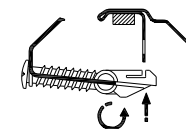

Fig 2.

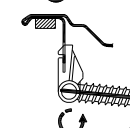

Fig 3

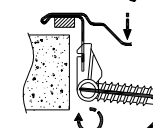

Fig 4.

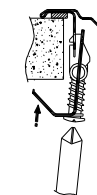

Fig 5.

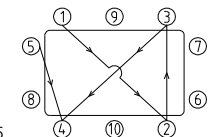

Fig 6.