



**Fitting type:** Inset

**Sink handing:** Left hand drainer

**Finish style:** Brushed steel

- **Min. base unit (bowl, tap & overflow only):** 800 mm
- **Packaged size L x W x D:** 1140 x 610 x 290mm
- **Supplied boxed or sleeved:** Boxed
- **Boxed weight:** 15.98 kg
- **Sink only weight:** 8.60 kg

- Thick gauge 18/10 stainless steel construction throughout
- Hand finished quality
- Uber square rectilinear styling
- Smooth lined luxury Orbit waste supplied as standard
- Premium quality handed design

**Included parts:**



1 x AX1012 (m)  
90mm Orbit wastes & rectangular overflow pack for 1.5 & 2.0 - short bolt



1 x AX1009 (m)  
1.5 or 2.0 Bowl pipework



1 x AX4006 (m)  
Fitting & care instructions & data sheet - st/st inset rotating clip



12 x AX1021 (m)  
Rotating fixing clip



1 x AX1023 (m)  
Inset self adhesive foam sealing strip, 3.0 meters

**Recommended accessories:**



1 x AX1011  
Tap stabilising bracket

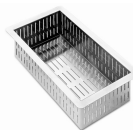

1 x AX1500  
Metrik 1/2 bowl colander

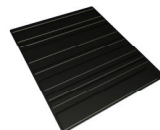

1 x AX2501  
Silicone drainer mat 330 x 390mm



1 x AX3004  
Bowl mat 308 x 371 R5

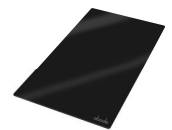

1 x AX2018  
Glass Chopping Board 471x264mm (366) - Black Gloss



1 x AX2502 or AX2503  
High & Dry drainer rack - Green & grey or White & grey

All accessories can be purchased directly from [www.abode-shop.co.uk](http://www.abode-shop.co.uk) or phone 01226 283434

**Materials and workmanship warranty summary:**

- Sink materials & workmanship 10 years.
- Waste kits 1 year.
- Connecting pipework 1 year.

**Care instructions:**

- Clean the products regularly using soapy water and a non abrasive cloth, regular cleaning will prevent the build up of lime scale and dirt.
- Avoid contact with corrosive or abrasive substances.
- After cleaning rinse thoroughly with clean water then dry.
- For more detail see supplied booklet or [www.abodedesigns.co.uk](http://www.abodedesigns.co.uk)

**Product dimensions and installation information:** note:



symbol indicates position of acoustic pad on stainless products.

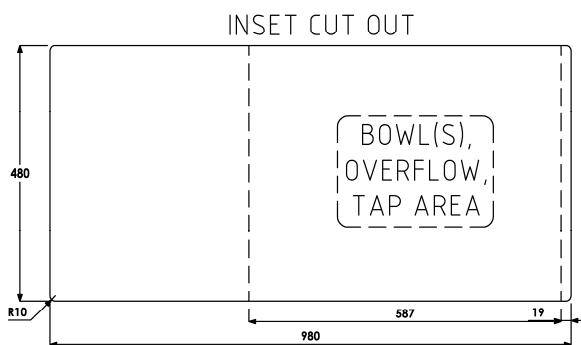
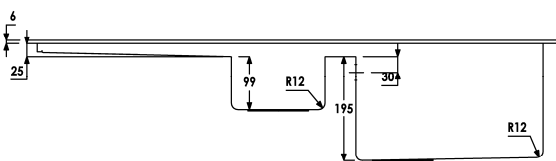
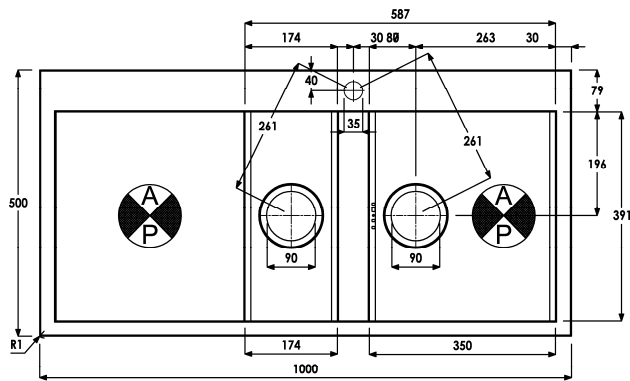

**Additional notes:**

**Overall product size:** 1000 x 500 x 234 corner radius 1mm

**Tap hole(s) detail:** 1 x Ø 35mm, pre-cut

**Compatibility with large square taps:** No known incompatibilities

**Wastehole(s) detail (mm):** 90 / 90 / N/A (nb. 90mm wastes accept a waste disposal unit)

**Min. base unit (refers to space required for bowl, tap and overflow only):** fits 800mm carcass

**Min. Recessed fitting width:** required (bowl(s), tap and overflow): 587mm

**\*Worktop cut out size:** 980x480 corner radius 10mm, for .DXF cut files please see [www.abode.eu](http://www.abode.eu)

**Min. & Max worktop depth or clip depth reach range:** 25 - 40mm

**Fitting template supplied?** No, use cut out instructions as supplied

**Dishwasher under drainer?** Distance from top of worktop to underside of the drainer 25mm



**\*Important, fabricator / installer notes for undermount & flushmount sinks:**

The cut out size indicated is aligned with outside edge of the bowl top radius (see example below).

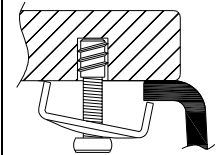

You should confirm with your client if the worksurface cutout is to be cut flush, inside or outside this suggested perimeter shape & size.

If you create the cutout smaller or larger than the indicated size then the fit of the accessories may be affected and should be physically checked.

**General:**

All details are provided in good faith but do not include the tolerances of the material or manufacturing process.

**We request that a test cutout is made in scrap timber and checked against the actual sink to be installed before committing to cutting the final worksurface.**

**Abode can not accept liability for problems or costs incurred by failure to follow this request.**

Note: the dimensions on ceramic fireclay products are subject to wider tolerances due to the nature of this natural material and the firing process.

CAD cutout files can be downloaded from [www.abodedesigns.co.uk](http://www.abodedesigns.co.uk)

**Bowl details:** (sizes in mm unless specified otherwise)

**Bowl 1 (typically main bowl):**

**Bowl 1 size L x W x D (mm):** 350 x 391 x 99

**Bowl 1 construction:** Welded, 1.00mm

**Bowl 1 floor radius (mm):** 12

**Bowl 1 Wastehole diameter (mm):** 90

**Bowl 1 overflow:** Slotted, barcode pattern

**Bowl 1 texture:** Brushed stainless

**Bowl 1 apx. volume (litres):** 20.80

**Bowl 2 (typically 1/2 or 3/4 bowl):**

**Bowl 2 size L x W x D (mm):** 174 x 391 x 99

**Bowl 2 construction:** Welded, 1.00mm

**Bowl 2 floor radius (mm):** 12

**Bowl 2 Wastehole diameter (mm):** 90

**Bowl 2 overflow:** N/A

**Bowl 2 texture:** Brushed stainless

**Bowl 2 apx. volume (litres):** 6.70

**Bowl 3:**

**Bowl 3 size L x W x D (mm):** N/A x N/A x N/A

**Bowl 3 construction:** N/A, N/Amm

**Bowl 3 floor radius (mm):** N/A

**Bowl 3 Wastehole diameter (mm):** N/A

**Bowl 3 overflow:** N/A

**Bowl 3 texture:** N/A

**Bowl 3 apx. volume (litres):** N/A