



### Product features:

- Metal construction throughout
- Quarter turn handle action for precise flow control
- Custom designed for lower range pressures
- Supplied complete with flexible tail pipes for fast simple fitting
- Swivel spout for maximum flexibility

### Packaged properties:

**Box length:** 375 mm      **Box depth:** 78 mm  
**Box width:** 175 mm      **Boxed weight:** 2.32 kg

**Includes pop up waste?:** Yes

**Additional comments:**

### Product dimensions:

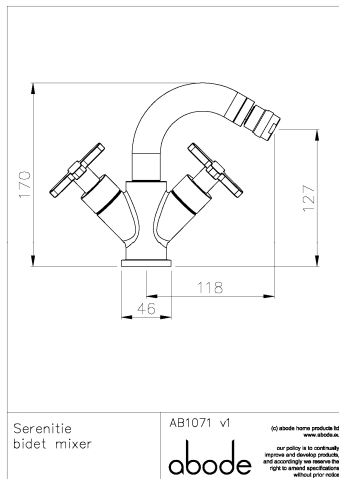

- **Overall Height / projection:** 170 mm
- **Exit reach:** 118 mm
- **Exit height:** 127 mm
- **Centre distance(s):**
- **Base diameter(s):** 46 mm
- **Product mounted where:** Surface
- **Recommended hole diameter:** 32 mm
- **Min. fitting depth required:**
- **Max. surface depth:** 60 mm

### Product flow characteristics:

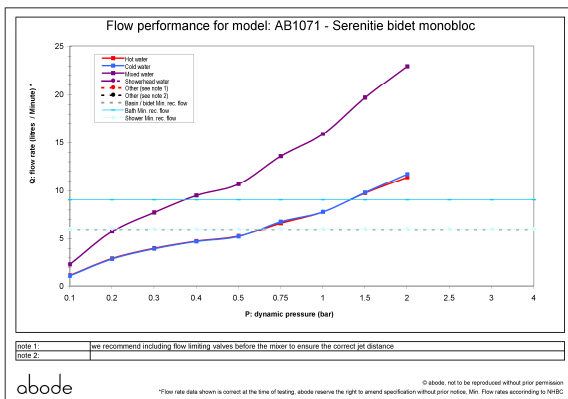

- **Min / Max water pressure:** 0.2 / 5 bar
- **Part G mixed flow rate at 3 bar (l/m):** >22.9
- **Max water temperature:** 70° C
- **Product flow characteristics:** Single flow
- **Aerator type:** White flow straightener
- **Includes output diverter?:** No
- **Control valve type:** 1/2" QT CD (8-20)
- **Non return valve position:**
- **Mesh particle filter size:**
- **Inlet / outlet size:** 1/2" F / m10
- **Inlet type / length:** Flexible / 380 mm
- **Shower hose type / length:**

### Warranty Summary (Full details available on request):

- Materials and workmanship defects warranted for 5 years
- Valves and working parts warranted for 5 years
- Surface warranty defects warranted for 1 year
- O-rings, hoses & gaskets warranted for 1 year

### Care instructions:

- Clean the mixers and showers regularly as required, using soap, do not use any other cleaners.
- Regular cleaning will prevent the build up of lime scale and dirt
- After cleaning rinse thoroughly with clean water to remove any cleaner residue
- Residues of liquid soaps, shampoos and shower foams can also cause damage, so rinse with clean water after using, avoid contact with any abrasives