

abode



SINK & TAP SPECIFICATION MANUAL

Adding a layer of luxury to your developments

WHY CHOOSE ABODE?

We are truly passionate about what we do and this is reflected through our ranges.

The Abode team have extensive experience and knowledge when it comes to kitchen sinks and taps. Our teams are dedicated to delivering the absolute best in performance and service in every aspect of what we do.

Established in 2002 our thirst for design, innovation, quality and service remains just as strong today as it was on day one.

Abode products add a layer of luxury to your developments, giving you the options to suit the development in hand.

From Regulation 4 approved hot water taps, taps in distinctive finishes and perfectly paired sinks with fast fit options. We have dedicated representatives with whom can discuss your requirements to ensure the optimum selection to meet your objectives is met every time.



Abode is part of Norcros PLC.

Norcros is a market leading supplier of high quality and innovative bathroom and kitchen products.

We have a well established, successful track record of serving consumers, architects, developers, retailer and wholesalers. Our emphasis is on strong branding, contemporary designs, trusted quality, outstanding service, innovations and breadth of range. We base our business on understanding our customers' needs. Norcros is a substantial group with consistent, high quality standards and considerable resources. We invest significantly and continuously in our people, brands, product development and processes and we aim to develop our business in both the quality of our products and the scale of our activities.



abode



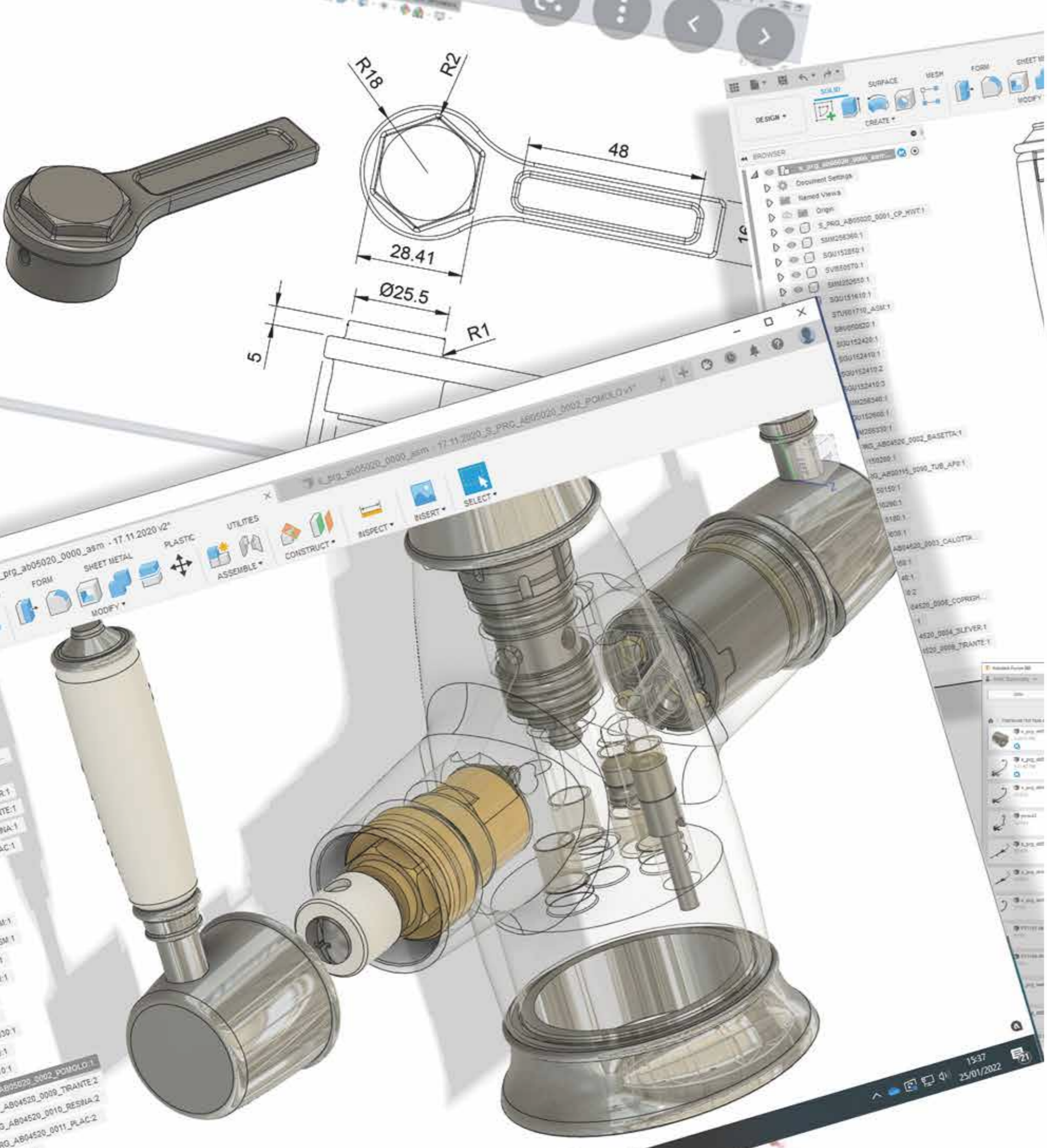

WHAT MAKES US TICK?

DESIGN, INNOVATION, QUALITY & SERVICE

Buying Abode means complete peace of mind. We have strict quality standards, investing in the very best components and latest manufacturing techniques to ensure long-life performance across our product portfolio.

We are so confident in the quality of our products that they carry a comprehensive warranty on defective material or workmanship. On top of that, our team are dedicated in providing superior customer service should you need us.

Innovation is at the heart of everything we do, and we do it with passion. Our product design team take projects from concept to completion through a carefully mapped process, ensuring we deliver the right products, at the right price, at the right time.

We can maintain speed to market by controlling our design agenda in the UK. We identify the trends, design and approve to ensure the demands of the market are met and the right products can make their way to the centre of your latest projects when you need them.

We are renowned for award winning product design and have been recognised by various industry awards.





QUALITY ASSURED

REST ASSURED WHEN YOU SPECIFY ABODE PRODUCTS. WE IMPLEMENT THE STRICTEST QUALITY STANDARDS FOR OUR PRODUCTS.



Taps:

- Designed to EN200.
- All models in this brochure are 3rd party approved by KIWA and/or WRAS.
- Plated to EN248 standards.
- Our brand taps undergo extensive quality testing including the following:
 - Ceramic disc valves tested for 200,000 cycles
 - Robotic production of parts for complete precision
 - 100% end of line testing
- Our sophisticated hand polishing, plating, powder coating and lacquering techniques are put through thorough testing to ensure optimum performance. This includes:
 - Salt spray testing for 100 - 200 hours
 - Surface resistance tests for 200 cycles using varying corrosives (acids, alcohols etc.)

Sinks:

- All sinks are approved to EN13310, conforming to CE and UKCA requirements
- Pipework and wastes are supplied with all Abode branded sinks and they conform to EN695.
- All Stainless Steel sinks are made from 304 grade stainless steel.

Proboil boilers:

- Our hot water product comply with LVD/EMC/RoHS standards according to CE and UKCA.
- All Proboil boilers either have WRAS certification or are in preparation for approval.

General:

- All manufacturing partners are ISO9001 approved.
- Principal manufacturing partners are either ISO14001 approved or have approval underway.
- Principal manufacturing partners are either SMETA approved or have approval underway.

All products should be installed in accordance with Local Water By Laws.

All information in this brochure was correct at the time of printing. Please check approval status before specifying a product.

All kitchen taps listed in this brochure held current WRAS/KIWA Regulation 4 approvals at the time of printing or were in the process of certification.



PROBOIL.2X

A RANGE FOR EVERY PROJECT AND BUDGET



The Pronteau by Abode collection features a range of WRAS/KIWA approved steaming hot water taps that have been designed to fit seamlessly into an array of kitchen designs. All components of our hot water tap systems have WRAS approval which we know is an essential accreditation for you and demonstrates our commitment to designing compliant products only in this category. We continue to develop and improve our offer, with new product designs underway each year so check in with us for our very latest offer.



abode
distinctly

Our most aspirational and unique kitchen tap designs, the premium designs on which the Abode brand was formed. This range consists of our latest innovative design forms, in an array of special finishes. The products that will inject the WOW factor into any kitchen.



abode

A range offering a broad array of design options with special finishes available on many of the ranges. The products in this range offer affordable style whilst maintaining the Abode quality promise, ensuring the perfect finishing touch and complete peace of mind.



CHOOSING THE RIGHT STYLE FOR THE JOB

Contemporary Single Lever Taps

With a variety of benefits, the single lever tap is a popular choice for many. Single lever mixers use less water than a monobloc as it takes less time to adjust the temperature to the right level. This makes them a more energy efficient choice, and with several sleek and streamlined designs available you're sure to find the perfect option.



Stainless Steel Taps

Stainless steel as a material has several well loved benefits including:

- It is a closer match to stainless steel sinks and appliances
- The material itself is 100% recyclable
- Stainless steel taps have no coating, they are just polished and brushed
- It is more durable and less likely to scratch, small scratches can be brushed out
- Stainless steel is a naturally hygienic material



Contemporary Dual Lever Taps

A monobloc allows complete symmetry for some of the most elegant tap designs.

Function and design are perfectly balanced in this range, with an array of classic and contemporary options, allowing you to choose something minimalist or something truly eye-catching.



Traditional Taps

Inspired by the classic era of British design and manufacturing, this refined selection of traditional mixertaps are the perfect pairing for shaker style cabinetry.



Pull Out & Professional Taps

The range consists of two different types of pull out tap; a true pull out and a pull around tap. On a true pull out, the hose is discreetly hidden inside the tap and allows the user to pull the hose out to its full set length. A pull around tends to be a professional style tap in which the hose is visible on the external of the tap and held in a handspray holder located on the end of the extension bar.

PRONTEAU™
by abode



Steaming Hot Water Taps

Useful technology is fast becoming the norm in the modern kitchen, with hot water taps being firmly among their number. Homeowners are increasingly looking for additional functionality from the kitchen tap, in the same way as they are appliances. Steaming hot water taps fulfil a need and have a range of benefits. See pages 12-15 for more information about Pronteau by Abode steaming hot water taps.

Water Filter Taps

The Abode Aquifier range features popular designs from our tap range as well as exclusive designs with the added benefit of a dedicated filtered water function – straight from the tap. All products are supplied with a WRAS approved filter.



THE ONLY RESTRICTION YOU SHOULD EVER NEED

ENGINEERED TO WITHSTAND!

All our flow limited taps have been extensively tested and had components beefed up to withstand the extra stresses flow restriction creates.

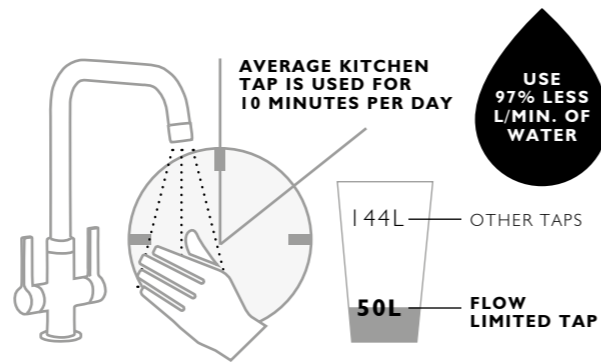

FLOW LIMITED TAPS

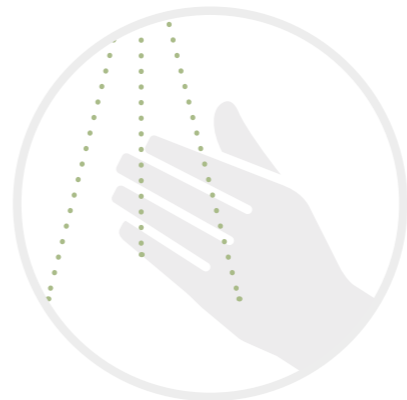

There are several UK regulations which all stipulate differing requirements for the flow limitation rate.

Building Regulations (Part G2) provide the standard law in force. Taking their guidance is how we have shaped our flow limited offer, our view is that flow limited taps should be 5LPM to comply with the maximum number of regulations. Accordingly, a tap which is limited to 5LPM will cover all schemes, no other flow rate should be needed.



AT1258-F5
Althia Single Lever
(5L/Min Flow Limited)
Chrome



AT2146-F5
Globe Single Lever
(5L/Min Flow Limited)
Chrome



AT1180-F5
New Media
(5L/Min Flow Limited)
Chrome



AT2070-F5
Quantic Monobloc
(5L/Min Flow Limited)
Chrome



AT1226-F5
Pico Swan Monobloc
(5L/Min Flow Limited)
Chrome



AT2134-F5
Pico Quad Monobloc
(5L/Min Flow Limited)
Chrome



PT1101-F5
Prostream Monobloc
(Flow Limited 5L)
Chrome



PT1111-F5
Prostyle Monobloc
(Flow Limited 5L)
Chrome

LIMIT RIGHT.. LIMIT 5

Regulation Type	Target flow rate (LPM at 3 bar)	Abode 5LPM FL Taps - Max at 3 bar
Building regs part g2 (standard)	8 (maximum)	✓
Building regs part g2 ("optional" REG37 water stressed areas)	6 (maximum)	✓
The Water Supply (water fittings) Regulations 1999	Minimum design flow rates: 6 litres / minute or 70% of this if a mixer-tap = 4.2 litres / minute (LPM at 3 bar)	✓
EN200 mixertaps (water saving type)	4-9 litres / minute (minimum)	✓



Other finishes and flow limitation levels are available on request, but, at extended lead times

WHY CHOOSE A PRONTEAU BY ABODE STEAMING HOT WATER TAP?

PRONTEAU™
by abode

WRAS APPROVAL PENDING

- Added convenience - save worktop space and time.
- Inject luxury with designs that sit perfectly in the kitchen designs of today.
- Water saving and a more environmentally friendly choice.
- Streamline the kitchen and add an instant talking point.
- Especially good in hard water areas.



1. Adding a Pronteau to the kitchen is guaranteed to make a difference and leave the user thinking how they ever got by without a steaming hot water tap.
2. Homeowners today crave those little added luxuries that can make such a difference to their daily life. Pronteau by Abode is a perfect example of that and with award winning, design leading styles on offer the product will take pride of place in any kitchen design.
3. As there is no need to fill the kettle every time a hot drink is made or a pan is to be filled, your customers will find that water and energy wastage in the household is minimal. Our filters are also 100% recyclable, a service managed by Abode.
4. Free up worktop and fridge space of kettles and filter jugs for clutter-free worktops and that extra fridge space that we often find ourselves needing. Demonstrate the working product to potential buyers for an added talking point.
5. Are you in a hard water area? Each time steaming hot water is dispensed it runs through the innovative Proboil filter, removing limescale which can often cause an unpleasant hot drink. Enjoy great tasting hot drinks every time.



WRAS APPROVAL PENDING



PRONTEAU™
by abode



WRAS APPROVAL PENDING



abode



Functions

3 IN 1

domestic cold, domestic hot and filtered steaming hot water

4 IN 1

domestic cold, domestic hot, filtered cold and filtered steaming hot water

Style

A variety of models, styles, popular finishes and boiler sizes allow you to tailor your experience of Pronteau hot water taps to ensure you get the right model for your household.

We have most recently launched our Slimline Prothia 3 IN 1 hot taps, to sit alongside the popular Prostream and Prostyle models. With another five ranges currently pending WRAS approval we're confident that Pronteau by Abode is the choice for developers seeking design flair as well as functionality. Not only that, our latest 4 IN 1 mechanical range, Propure offer hot and cold domestic supply along with filtered steaming hot and filtered cold drinking water.

Why 98 degrees?

When we developed our innovative range of steaming hot water taps for launch in 2016 we took into consideration every aspect of safety, not only for the dispensing of the steaming hot water but also the maximum temperature requirements for the stored water in the boiler. This is the main reason our products store water to a maximum temperature of 98°C, this makes our product fully compliant with Part G(3) of the UK Building Regulations, and all Pronteau taps, boilers and filters are WRAS approved or WRAS pending.



STEAMING HOT WATER TAPS

PRONTEAUTM
by abode

The HotKey® Collection

STEAMING

All products in the HotKey® collection offer 4 functions; steaming hot filtered water, refreshing filtered cold water and everyday hot and cold water.

STYLISH

The HotKey® collection offers an array of stylish designs in a range of finishes; Chrome, Brushed Nickel, Matt Black, Antique Brass and Brushed Brass.

SAFE

The patented Pronteau HotKey® technology could just be the safest way to dispense steaming hot water.

Without the HotKey® the steaming hot water cannot be activated, hide it up high away from little ones and the tap will only perform as a 3-way mixer tap.

As well as this safety benefit, this tap is also great for anyone with dexterity difficulties or conditions such as arthritis where pushing down, turning and sliding may be more complicated.

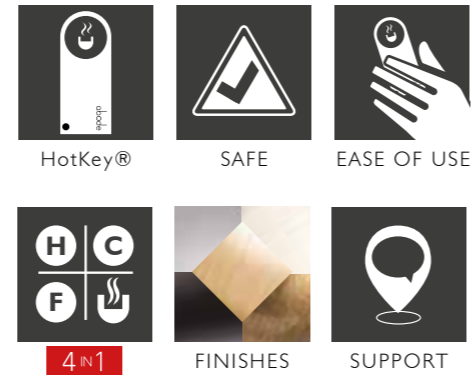

STEAMING | STYLISH | SAFE

PROFILE MONOBLOC



Code	Finish
PT1001-2	Chrome
PT1002-2	Brushed Nickel
PT1026-2	Matt Black

Bar Pressure

Min 2.0 bar pressure required (cold)
Min 0.5 bar pressure required (hot)



PROJECT MONOBLOC



Code	Finish
PT1003-2	Chrome
PT1004-2	Brushed Nickel
PT1027-2	Matt Black
PT1052	Brushed Brass

Bar Pressure

Min 2.0 bar pressure required (cold)
Min 0.5 bar pressure required (hot)



PROVINCE MONOBLOC



Code	Finish
PT1005-2	Chrome
PT1006-2	Brushed Nickel
PT1019-2	Antique Brass

Bar Pressure

Min 0.5 bar pressure required



PROBOIL.4E



- Designed exclusively for the Pronteau 4 IN 1 HotKey® collection
- Provides 4 litres of instant steaming hot water
- Compact size leaves plenty of space in the cabinet (Even fits under a Belfast or apron front sink)
- LCD display shows true tank temperature
- Adjustable temperature - 75 to 98 degrees
- Installation and maintenance services available
- Filter life indicator
- Colour coded quick fix connections
- Supplied with a premium water optimisation filter, which is part of the free of charge Abode filter recycle scheme

For more information visit www.pronteau.co.uk

All Pronteau by Abode systems are supplied with a WRAS approved filter.



STEAMING HOT WATER TAPS

PRONTEAU™
by abode

INDUSTRIA MONOBLOC

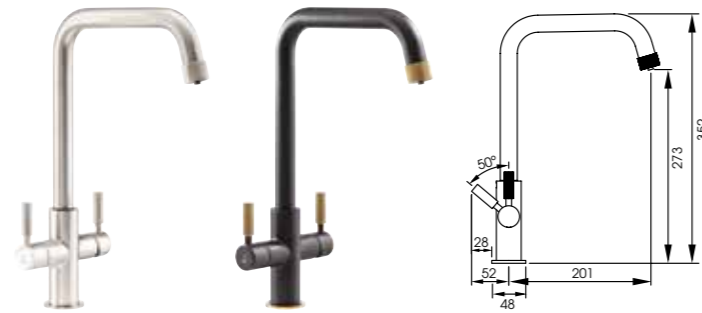

Code	Finish
PT1196	Brushed Nickel
PT1197	Matt Black/ Antique Brass

Bar Pressure

Min 1.5 bar pressure required (cold)
Min 0.8 bar pressure required (hot)

WRAS PENDING

PROTHIA QUAD SPOUT



Code	Finish
PT1140	Chrome
PT1141	Brushed Nickel
PT1142	Matt Black
PT1143	Brushed Brass
PT1144	Urban Copper

Bar Pressure

Min 1.5 bar pressure required (cold)
Min 0.8 bar pressure required (hot)



PROTHIA SWAN SPOUT



Code	Finish
PT1130	Chrome
PT1131	Brushed Nickel
PT1132	Matt Black
PT1133	Brushed Brass
PT1134	Urban Copper

Bar Pressure

Min 1.5 bar pressure required (cold)
Min 0.8 bar pressure required (hot)



PROSTREAM MONOBLOC

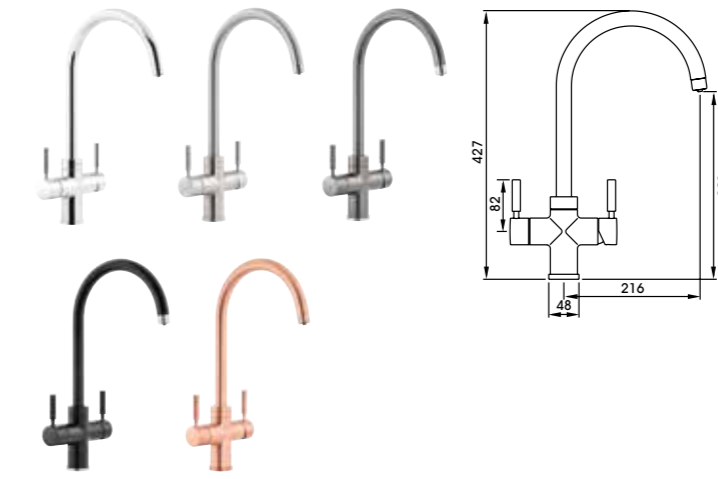

Code	Finish
PT1101	Chrome
PT1102	Brushed Nickel
PT1103	Graphite
PT1104	Matt Black
PT1105	Urban Copper

Flow Restricted Option

PT1101-F5 | Chrome

Bar Pressure

Min 1.5 bar pressure required (cold)
Min 0.75 bar pressure required (hot)



Prothia
Swan Spout
in Matt Black

PROTRAD 3 IN 1 MONOBLOC



Code	Finish
PT1190	Chrome
PT1191	Brushed Nickel
PT1192	Antique Brass

Bar Pressure

Min 1.5 bar pressure required (cold)
Min 0.75 bar pressure required (hot)

WRAS PENDING

STEAMING HOT WATER TAPS

PRONTEAU™
by abode

PROTRAD 4 IN 1 MONOBLOC

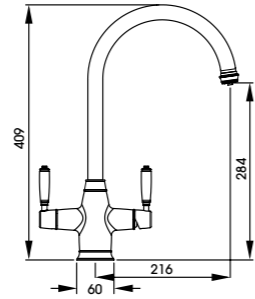

Code	Finish
PT1111	Chrome
PT1112	Brushed Nickel
PT1113	Antique Brass

Flow Restricted Option

PT1111-F5	Chrome
-----------	--------

Bar Pressure

Min 1.5 bar pressure required (cold)
Min 0.8 bar pressure required (hot)

WRAS PENDING

PROPURE QUAD SPOUT

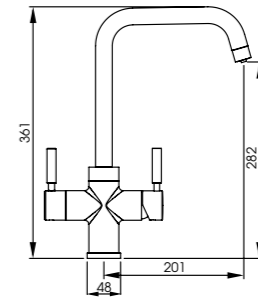

Code	Finish
PT1160	Chrome
PT1161	Brushed Nickel
PT1162	Matt Black
PT1163	Brushed Brass
PT1164	Urban Copper

Bar Pressure

Min 1.5 bar pressure required (cold)
Min 0.5 bar pressure required (hot)



2205715

SCANDI-X

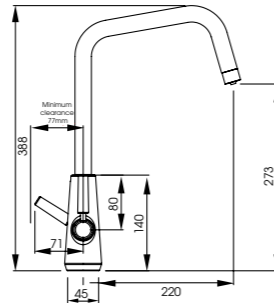

Code	Finish
PT1300	Matt White
PT1301	Matt Black
PT1302	Scandi Grey

Bar Pressure

Min 1.5 bar pressure required (cold)
Min 1.5 bar pressure required (hot)

WRAS PENDING

PROPURE SWAN SPOUT

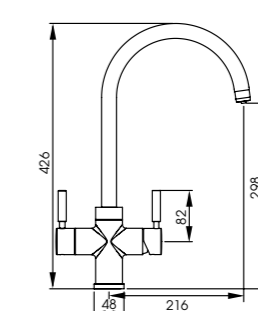

Code	Finish
PT1150	Chrome
PT1151	Brushed Nickel
PT1152	Matt Black
PT1153	Brushed Brass
PT1154	Urban Copper

Bar Pressure

Min 1.5 bar pressure required (cold)
Min 0.5 bar pressure required (hot)



2205715

PROSTYLE MONOBLOC

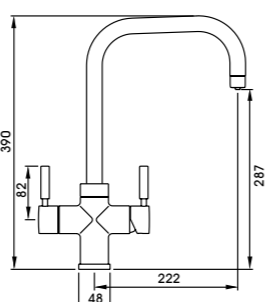

Code	Finish
PT1111	Chrome
PT1112	Brushed Nickel
PT1113	Graphite
PT1114	Matt Black
PT1115	Urban Copper

Flow Restricted Option

PT1111-F5	Chrome
-----------	--------

Bar Pressure

Min 1.5 bar pressure required (cold)
Min 0.75 bar pressure required (hot)



1904337

PROBOIL.2X



- Compact 2.1L stainless steel tank
- Digital temperature display
- Adjustable temperature - 75 to 98 degrees
- Factory calibrated temperature
- Boil dry prevention
- Filter life indicator
- Colour coded quick fix connections

For more information visit www.pronteau.co.uk

All Pronteau by Abode systems are supplied with a WRAS approved filter.



1709098



CONTEMPORARY SINGLE LEVER TAPS

PRIME SINGLE LEVER

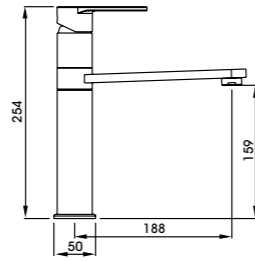

Code	Finish
AT1254	Chrome
AT1255	Brushed Nickel
AT2104	Matt Black

Bar Pressure

Min 0.3 bar pressure required



ALTHIA SINGLE LEVER

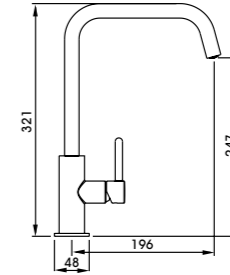

Code	Finish
AT1258	Chrome
AT1259	Brushed Nickel
AT1269	Graphite
AT1270	Matt Black
AT1272	Urban Copper
AT2103	Brushed Brass
AT2207	Matt White
AT2208	Scandi Grey
AT2209	Nude
AT2210	Terracotta

Flow Restricted Option

AT1258-F5 | Chrome

Bar Pressure

Min 0.75 bar pressure required



HYDRUS SINGLE LEVER

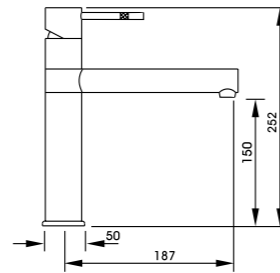

Code	Finish
AT1088	Chrome
AT1089	Brushed Nickel

Bar Pressure

Min 0.5 bar pressure required



GLOBE SINGLE LEVER

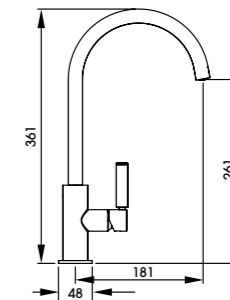

Code	Finish
AT2146	Chrome
AT2147	Brushed Nickel
AT2148	Brushed Brass
AT2149	Matt Black

Flow Restricted Option

AT2146-F5 | Chrome

Bar Pressure

Min 0.75 bar pressure required



NEW MEDIA SINGLE LEVER

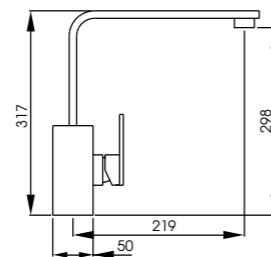

Code	Finish
AT1180	Chrome
AT1181	Brushed Nickel
AT1182	Matt Black

Flow Restricted Option

AT1180-F5 | Chrome

Bar Pressure

Min 0.5 bar pressure required



SPECTO SINGLE LEVER

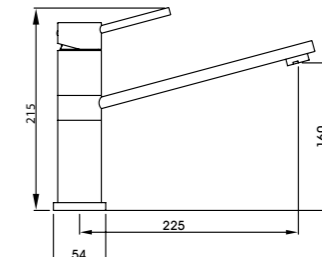

Code	Finish
AT1224	Chrome
AT1225	Brushed Nickel

Bar Pressure

Min 0.6 bar pressure required

WRAS PENDING

CONTEMPORARY DUAL LEVER TAPS

NEXA MONOBLOC

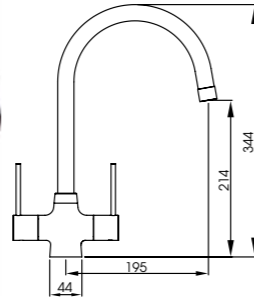

Code	Finish
AT1222	Chrome
AT1223	Brushed Nickel

Bar Pressure
Min 0.3 bar pressure required



GLOBE MONOBLOC

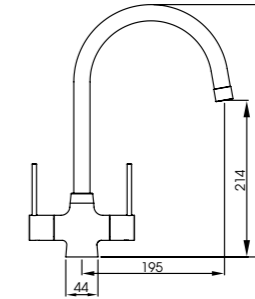

Code	Finish
AT2138	Chrome
AT2139	Brushed Nickel
AT2140	Brushed Brass
AT2141	Matt Black

Bar Pressure
Min 0.5 bar pressure required



ATIK MONOBLOC

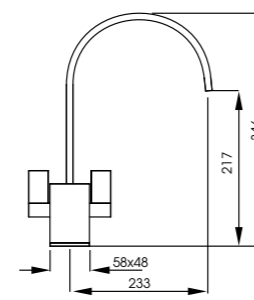

Code	Finish
AT1148	Chrome

Bar Pressure
Min 0.4 bar pressure required



PICO MONOBLOC

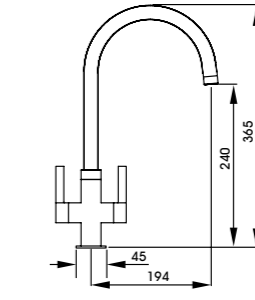

Code	Finish
AT1226	Chrome
AT1227	Brushed Nickel
AT2045	Brushed Brass
AT2095	Matt Black

Flow Restricted Option
AT1226-F5 | Chrome

Bar Pressure
Min 0.5 bar pressure required



ATLAS MONOBLOC

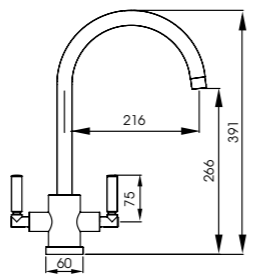

Code	Finish
AT1053	Chrome
AT1054	Brushed Nickel
AT2097	Matt Black
AT2096	Brushed Brass

Bar Pressure
Min 0.3 bar pressure required



PICO QUAD

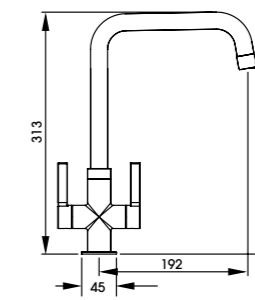

Code	Finish
AT2134	Chrome
AT2135	Brushed Nickel
AT2136	Brushed Brass
AT2137	Matt Black

Flow Restricted Option
AT2134-F5 | Chrome

Bar Pressure
Min 0.4 bar pressure required



CONTEMPORARY DUAL LEVER TAPS

QUANTIC MONOBLOC

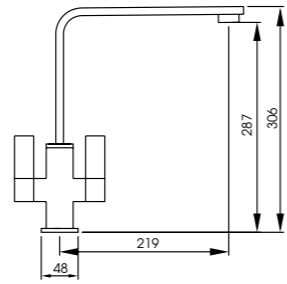

Code	Finish
AT2070	Chrome
AT2105	Matt Black
AT2182	Brushed Brass

Flow Restricted Option
AT2070-F5 | Chrome

Bar Pressure
Min 0.3 bar pressure required



OPHELIA SINGLE LEVER PULL OUT SPRAY

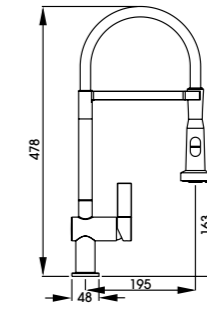

Code	Finish
AT2074	Chrome

Bar Pressure
Min 0.75 bar pressure required



LINEAR FLAIR MONOBLOC

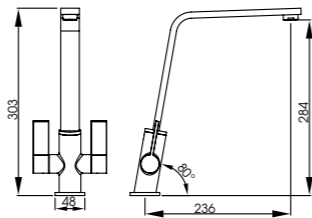

Code	Finish
AT1220	Chrome
AT1221	Brushed Nickel

Bar Pressure
Min 0.5 bar pressure required

WRAS PENDING

VIRTUE NERO PULL OUT

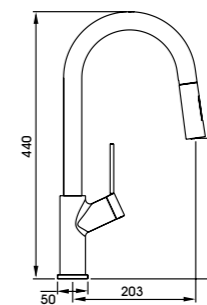

Code	Finish
AT1244	Chrome

Bar Pressure
Min 1.5 bar pressure required



PULL OUT & PROFESSIONAL TAPS

GENIO MIXERTAP

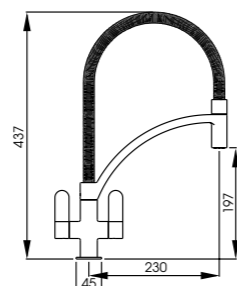

Code	Finish
AT2071	Chrome
AT2183	Matt Black

Bar Pressure
Min 1.0 bar pressure required



TRADITIONAL TAPS

LUDLOW MONOBLOC

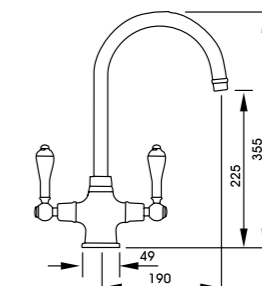

Code	Finish
AT1026	Chrome
AT1216	Brushed Nickel
AT1028	Antique Brass

Bar Pressure
Min 0.2 bar pressure required

WRAS PENDING

STAINLESS STEEL TAPS

PROPUS SINGLE LEVER

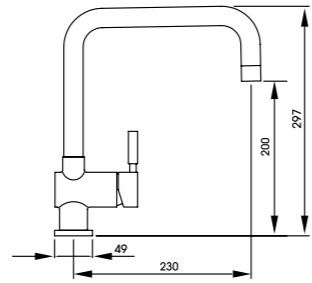

Code	Finish
AT1070	Stainless Steel

Bar Pressure
Min 0.5 bar pressure required



SWAY SINGLE LEVER

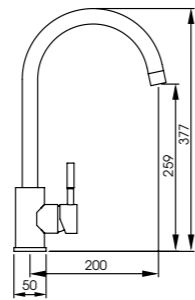

Code	Finish
AT2178	Stainless Steel

Bar Pressure
Min 0.5 bar pressure required



AIRO MONOBLOC

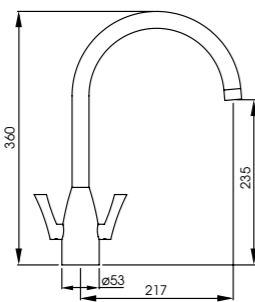

Code	Finish
AT2075	Stainless Steel

Bar Pressure
Min 0.3 bar pressure required



FOCAL MONOBLOC

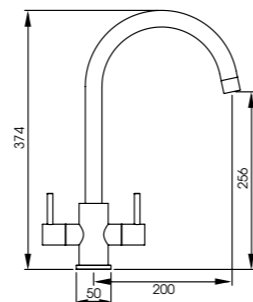

Code	Finish
AT2177	Stainless Steel

Bar Pressure
Min 0.3 bar pressure required



WATER FILTER TAPS

AQUIFIER™

ATLAS AQUIFIER

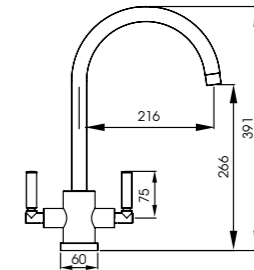

Code	Finish
AT2003	Chrome
AT2004	Brushed Nickel
AT2098	Brushed Brass
AT2099	Matt Black

Bar Pressure
Min 0.3 bar pressure required



ORCUS 3 WAY AQUIFIER

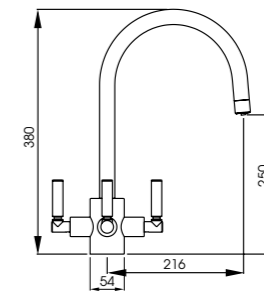

Code	Finish
AT2072	Chrome

Bar Pressure
Min 0.5 bar pressure required



GOSFORD AQUIFIER

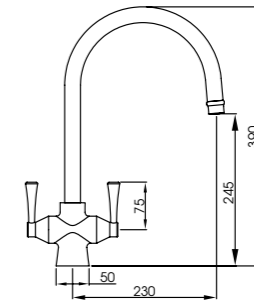

Code	Finish
AT2005	Chrome
AT2006	Brushed Nickel

Bar Pressure
Min 0.3 bar pressure required



SELECTING A SINK



MATERIAL

STAINLESS STEEL: Stainless Steel is a timeless material which remains a popular choice. It is often a perfect match to the kitchen appliances so provides a coordinated finishing touch. As well as the aesthetics, it is easy to maintain and is extremely durable. All Abode sinks are constructed from premium 304 grade stainless steel and are available in an array of designs.



GRANITE: SiOForm® is a unique material solution engineered specially for our granite kitchen sink collection. The material is primarily made of pure and natural quartz which makes it very strong and durable, perfect for the kitchen environment. SiOForm® products have a uniform void-free structure and are resistant to dry temperatures up to 280°. Granite sinks also retain the water temperature in the bowl better than stainless steel. Our range consists of several unique designs in various shapes and sizes. In addition, the white, grey and black colour options offer a contemporary styled solution to create a striking focal point in the kitchen.



SiOForm® is available in the following colours:



CERAMIC: Our ceramic sinks are constructed from the finest grade fireclay and are hand finished for a premium quality finish. This traditional classic is available in undermount, apron front and inset options, providing an elegant finish every time. The glazing process ensures a long lasting and durable finish.



All Abode sinks are supplied with wastes and pipework in the box (unless we have a sleeved option available, these variants are not supplied with pipework to remove cost - please speak to an Abode representative for options).



FLUSH PLATE OVERFLOW

- Matrix R0
- Matrix R15
- Studio
- Steel Belfast
- Sandon
- Neron
- Verve



ORBIT WASTE

- Matrix R0
- Matrix R15
- Matrix R50
- Studio
- Steel Belfast
- Matrix GR15
- Denton
- Sandon
- Aspekt
- Dune
- Zero
- Connekt
- Ixis
- Neron
- Verve



PIPEWORK SUPPLIED WITH:-

- 1.0 Bowl sinks

PIPEWORK SUPPLIED WITH:-

- 1.5 Bowl sinks
- 2.0 Bowl sinks

STAINLESS STEEL UNDERMOUNTS

MATRIX R0

FIVE BOWL SIZES AVAILABLE

Material	304 Grade Stainless Steel
Finish	Brushed Steel
Cabinet Size (mm)	450 - 800
Gauge Steel	1mm
Fitting	Undermount
Waste & Pipework included?	Yes

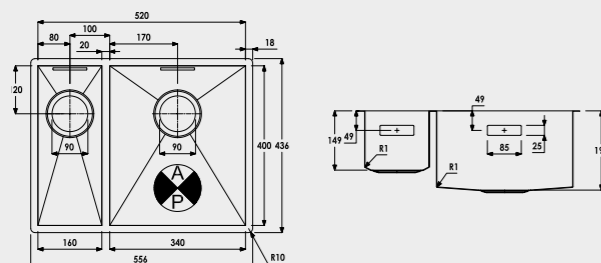

MATRIX R50

SIX BOWL SIZES AVAILABLE

Material	304 Grade Stainless Steel
Finish	Polished Steel
Cabinet Size (mm)	450 - 800
Gauge Steel	0.7mm
Fitting	Undermount
Waste & Pipework included?	Yes

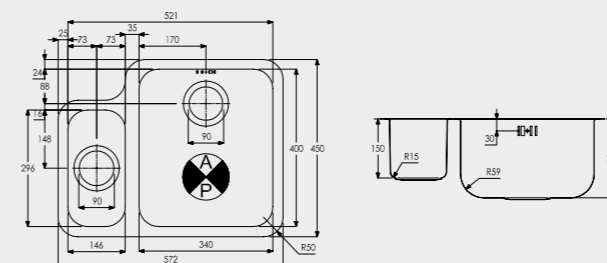

MATRIX R15

SIX BOWL SIZES AVAILABLE

Material	304 Grade Stainless Steel
Finish	Brushed Steel
Cabinet Size (mm)	500 - 1000
Gauge Steel	1mm
Fitting	Undermount or low profile inset
Waste & Pipework included?	Yes

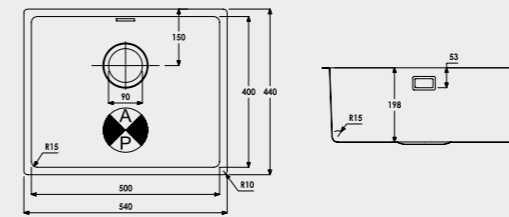

Low profile inset installation

STAINLESS STEEL UNDERMOUNTS

STAINLESS STEEL BELFAST

ONE BOWL SIZE

Material	304 Grade Stainless Steel
Finish	Brushed Steel
Cabinet Size (mm)	600 Belfast base unit
Gauge Steel	1.2mm
Fitting	Sit on
Waste & Pipework included?	Yes

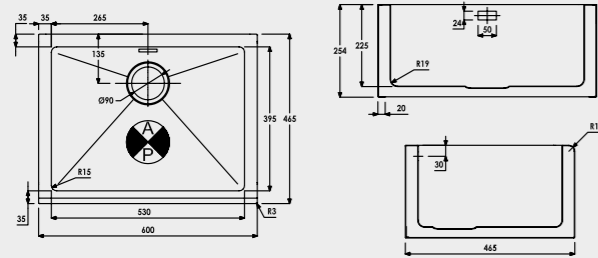

GRANITE UNDERMOUNTS

MATRIX GR15

FOUR BOWL SIZES AVAILABLE

Material	Granite
Available colours	Grey Metallic, Black Metallic, White
Cabinet Size (mm)	500 - 800
Fitting	Undermount or low profile inset
Waste & Pipework included?	Yes

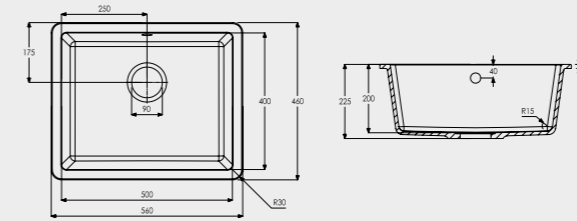

STUDIO COMPACT

ONE BOWL SIZE

Material	304 Grade Stainless Steel
Finish	Brushed Steel
Cabinet Size (mm)	450/600
Gauge Steel	1mm
Fitting	Undermount or low profile inset
Waste & Pipework included?	Yes

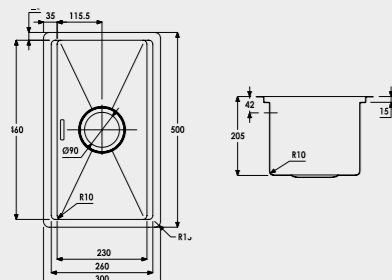

- Two installation options available:**
- Horizontal mounting position (600mm cabinet requirement)
 - Vertical (450mm cabinet requirement)



DENTON

ONE BOWL SIZE

Material	Granite
Available colours	Grey Metallic
Cabinet Size (mm)	450/600
Fitting	Undermount
Waste & Pipework included?	Yes

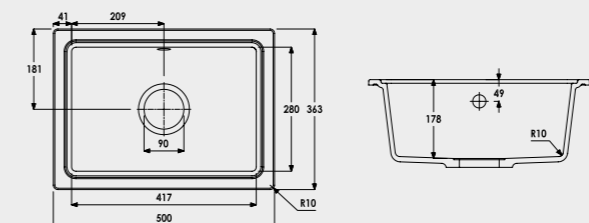

- Two installation options available:**
- Horizontal mounting position (600mm cabinet requirement)
 - Vertical (450mm cabinet requirement)



GRANITE UNDERMOUNTS

SYNCHRONIST

FOUR BOWL SIZES AVAILABLE

Material	Granite
Available Colours	White Granite, Grey Metallic Granite, Black Metallic Granite
Cabinet Size (mm)	500 - 800
Fitting	Undermount or low profile inset
Waste & Pipework included?	Yes

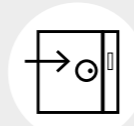
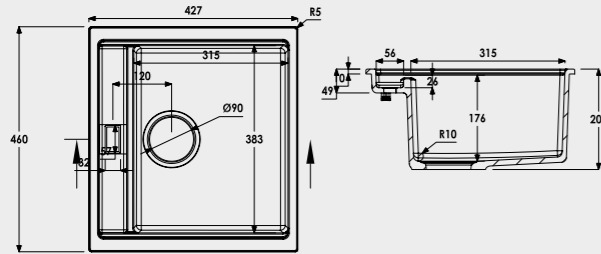

Space saving solution with expansive bowl capacity.



Range of bowl sizes with flexible 2 IN 1 installation option, choose to mount inset or undermount.

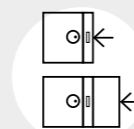

Options with and without drainer available.

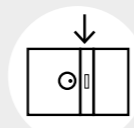

All products have a 0.25 section where the flush plate overflow sits. Use for additional storage of kitchen accessories.

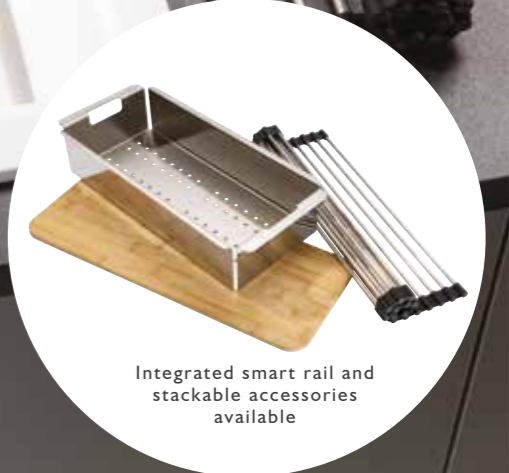

Integrated smart rail and stackable accessories available



CERAMIC UNDERMOUNTS

BELFAST



ONE BOWL SIZE

Material	Ceramic
Finish	Gloss White
Cabinet Size (mm)	600 Belfast base unit
Fitting	Sit on
Waste Type	60mm basket strainer (included)
Pipework included?	Yes

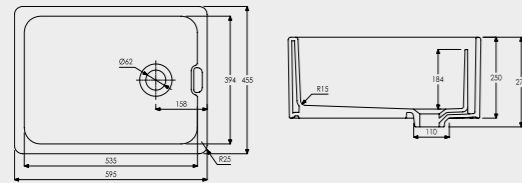

SANDON

FOUR BOWL SIZES AVAILABLE

Material	Fireclay Ceramic
Finish	Gloss White
Cabinet Size (mm)	500 - 800
Fitting	Undermount or Inset
Waste & Pipework included?	Yes

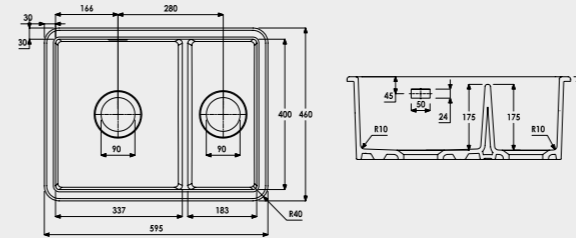

PROVINCIAL

TWO BOWL SIZES AVAILABLE

Material	Fireclay Ceramic
Finish	White
Cabinet Size (mm)	800
Fitting	Sit on
Waste Type	2 x 90mm basket strainers (included)
Pipework included?	Yes



Two options: large single bowl or large double bowl

- Punched tap hole on double bowl option
- Worktop can be cut to cover tap deck

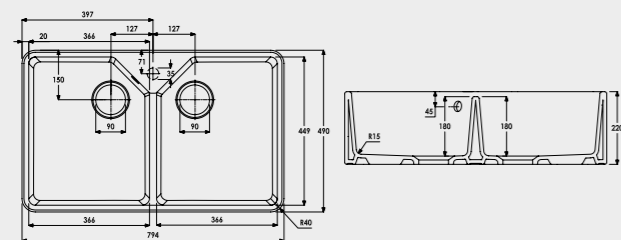

GRANITE INSETS

ASPEKT



TWO BOWL SIZES AVAILABLE

Material	Granite
Finish	Black Metallic, White
Cabinet Size (mm)	450 or 600 (minimum)
Fitting	Inset
Reversible	Yes
Waste & Pipework included?	Yes

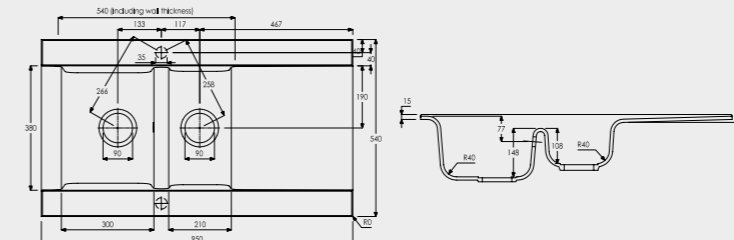

GRANITE INSETS

DUNE



THREE BOWL SIZES AVAILABLE

Material	Granite
Finish	Black Metallic, White
Cabinet Size (mm)	600
Fitting	Inset
Reversible	Yes
Waste & Pipework included?	Yes

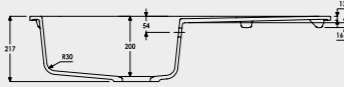
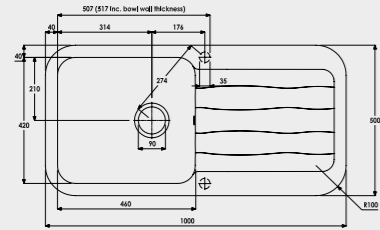

XCITE



TWO BOWL SIZES AVAILABLE

Material	Granite
Finish	Black Metallic, White
Cabinet Size (mm)	600
Fitting	Inset
Reversible	Yes
Waste & Pipework included?	Yes

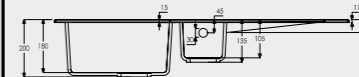
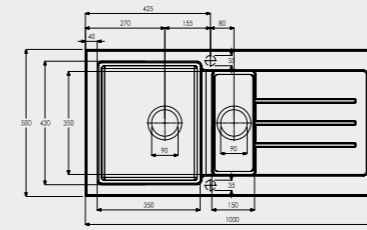

ORIEL



TWO BOWL SIZES AVAILABLE

Material	Granite
Finish	Black Metallic, White
Cabinet Size (mm)	600
Fitting	Inset
Reversible	Yes
Waste & Pipework included?	Yes

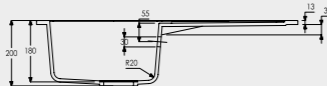
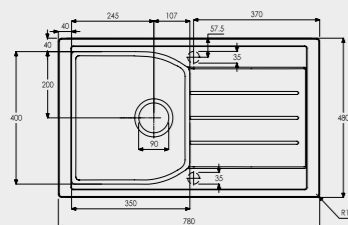

ZERO



FOUR BOWL SIZES AVAILABLE

Material	Granite
Finish	Black Metallic, Grey Metallic, White
Cabinet Size (mm)	450 - 600
Fitting	Inset
Reversible	Yes
Waste & Pipework included?	Yes

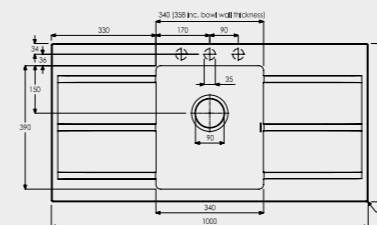

- Hidden Orbit overflow design.
- With part formed tap holes to be drilled to your preference on installation.
- With only a 450mm minimum base unit requirement and double drainer design, the AW3008/AW3108 is the perfect option for compact/studio kitchens.

CERAMIC INSETS

ACTON



TWO BOWL SIZES AVAILABLE

Material	Fireclay Ceramic
Finish	Gloss White
Cabinet Size (mm)	600
Fitting	Inset
Reversible	Yes
Waste Type	90mm basket strainer (included)
Pipework included?	Yes

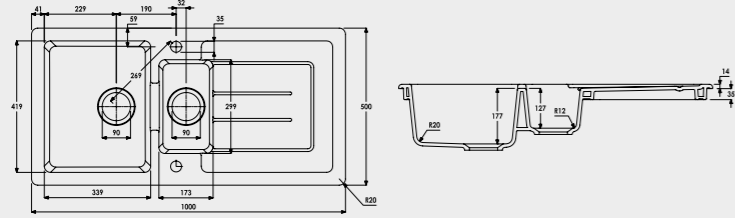

STAINLESS STEEL INSETS

CONNEXT



THREE BOWL SIZES AVAILABLE

Material	304 Grade Stainless Steel
Finish	Unbrushed Steel
Cabinet Size (mm)	450 - 600
Gauge Steel	0.8mm
Fitting	Inset
Waste & Pipework included?	Yes

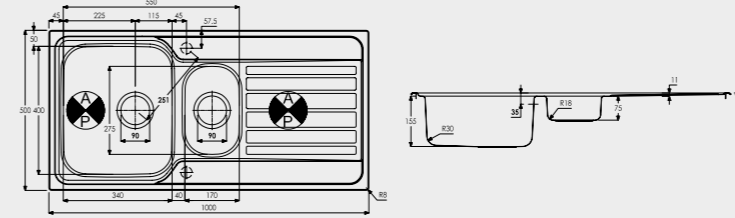

MILFORD



TWO BOWL SIZES AVAILABLE

Material	Fireclay Ceramic
Finish	White
Cabinet Size (mm)	450 - 600
Fitting	Inset
Reversible	Yes
Waste Type	90mm basket strainer (included)
Pipework included?	Yes

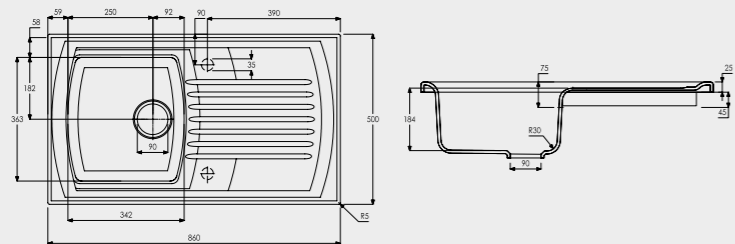

IXIS



THREE BOWL SIZES AVAILABLE

Material	304 Grade Stainless Steel
Finish	Brushed Steel
Cabinet Size (mm)	450 - 600
Gauge Steel	0.8mm
Fitting	Inset
Reversible	Yes
Waste & Pipework included?	Yes

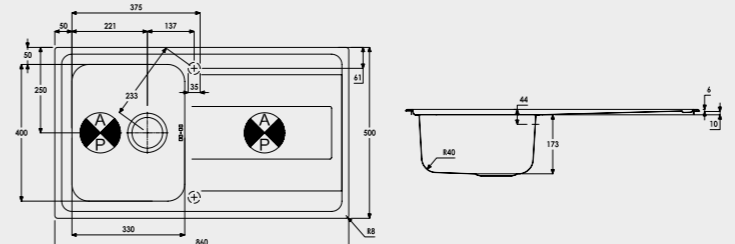

STAINLESS STEEL INSETS

MIKRO



TWO BOWL SIZES AVAILABLE

Material	304 Grade Stainless Steel
Finish	Unbrushed Steel
Cabinet Size (mm)	450 - 600
Gauge Steel	0.7mm
Fitting	Inset
Reversible	Yes
Waste & Pipework included?	Yes

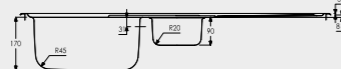
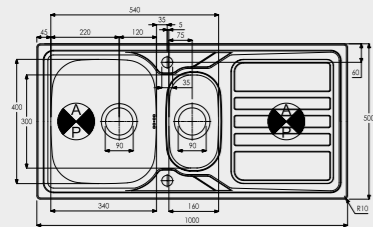

TRYDENT



TWO BOWL SIZES AVAILABLE

Material	304 Grade Stainless Steel
Finish	Brushed Steel
Cabinet Size (mm)	450 - 600
Gauge Steel	0.6mm
Fitting	Inset
Reversible	Yes
Waste & Pipework included?	Yes



- Sleeved option also available. This cost saving option includes no pipework.

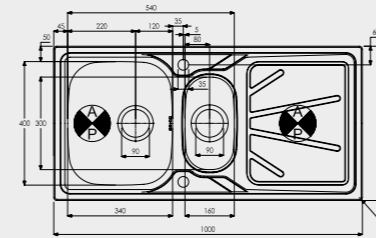

NERON



THREE BOWL SIZES AVAILABLE

Material	304 Grade Stainless Steel
Finish	Brushed Steel
Cabinet Size (mm)	500 - 600
Gauge Steel	0.7mm
Fitting	Inset
Reversible	Yes
Waste & Pipework included?	Yes



- Design point
- Flush-plate overflow integrated beside the drainer on one bowl options.

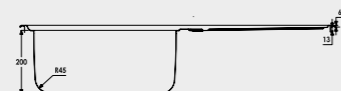
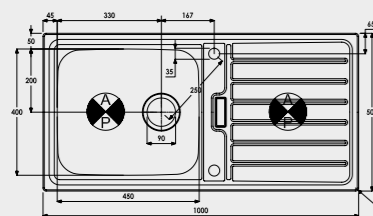

VERVE



TWO BOWL SIZES AVAILABLE

Material	304 Grade Stainless Steel
Finish	Brushed Steel
Cabinet Size (mm)	600
Gauge Steel	1mm
Fitting	Inset
Reversible	Yes
Waste & Pipework included?	Yes

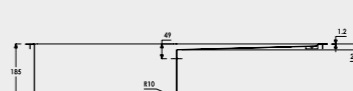
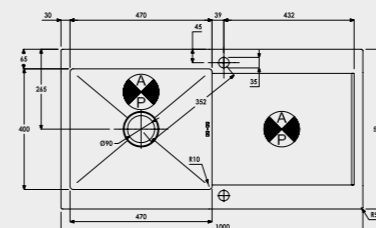

Streamline, Simplify, Synchronise

with

SYSTEM SYNC

The innovative System Sync, designed to work with you and your kitchen.

Overflowing with features and versatility that offers up superlative functionality, maximises workflow, and liberates worktops.

System Sync offers so much more than bowls to simply wash up in, it allows for a whole host of kitchen tasks to be performed super efficiently - saving time and space for those things that matter.



1/ SELECT YOUR BOWL / BOWL COMBINATION

Caddy Bowl



AW5141

Stainless Steel

length 220mm
width 440mm
depth 156mm
bowl 1 capacity 5.6L
min base unit 450mm

Can be undermounted or inset

Single bowl



AW5142

Stainless Steel

length 380mm
width 440mm
depth 206mm
bowl 1 capacity 16.7L
min base unit 450mm

Can be undermounted or inset

Large single bowl



AW5143

Stainless Steel

length 540mm
width 440mm
depth 206mm
bowl 1 capacity 24.90L
min base unit 600mm

Can be undermounted or inset

2/ SELECT ACCESSORIES

Abode recommends opting for the Accessory Trio which includes; a FlexRack which offers limitless uses, whether it's keeping hot pans away from your worktop or utilising it as a draining board after you've been cooking up a storm. The multi-functional prep board and colander. The complete solution to make meal preparation a breeze. However each accessory is available individually if you prefer.

Accessory trio



AX1142

Includes:

- AX2024 System Sync Prep board
- AX1508 System Sync Colander
- AX2506 System Sync Flex Rack





From the *Micro* to the *Mega*

Open up a world of possibilities and build your perfect sink solution with System Sync, allowing you to create a customisable, smart solution for all kinds of spaces, from the small to the spacious.



SO WHAT'S
IMPORTANT
ON YOUR
SPECIFICATION
CHECKLIST?



- 
WATER SAVING: We have a range of products which are available in flow limited options. Limited to 5LPM for a significant reduction in water consumption.
- 
WATER QUALITY: An Aquifier tap or 4 IN 1 steaming hot water tap filters particulates from water, reduces the taste and odour of chlorine and reduces hardness from the water.
- 
HEALTH: Having filtered cold water on tap will hopefully encourage the consumption of more water. Fill a reusable water bottle each day directly from the tap.
- 
ENVIRONMENT: By removing the need for bottled mineral water, every home with an Aquifier product or 4 IN 1 hot water tap is doing their bit for the environment by reducing single use plastic consumption.
- 
COST: If bottled mineral water is a frequent purchase in your household you can save considerable amounts each year by switching to an Aquifier or Swich product.
- 
SPACE SAVING: If you previously had a water filtration jug or bought bottled water, just think how much space you can free up in the fridge.
- 
APPLIANCE HEALTH: If you're in an area with particularly hard water you will notice that the kettle suffers as a result of the limescale build up over time. Fill your kettle with filtered water and prolong its life.

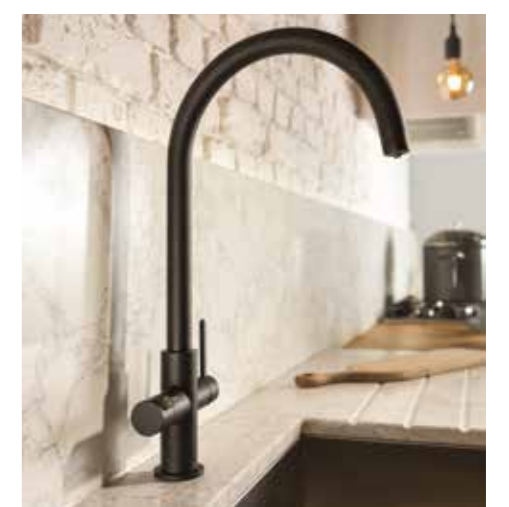

abode



PRONTEAUTM
by abode

If space is of a premium we have multi-functional compact sinks which can be fit either horizontally or vertically as the space allows and our Studio sink comes with 3 accessories allowing the sink to double up as a hard working task area.

Pair the sink with the slimline Prothia steaming hot water tap or Althia single lever tap for the perfect combined compact solution.

This is also a great combination for larger kitchens which call for a second sink.

As priorities and our way of living changes, people are spending more time at home and buyers are looking for luxury elements within their home.

Consider upgrades such as a standard tap to steaming hot water tap, water filter tap or professional/pull out tap to add extra talking points which could make all the difference.



abode

Ease of fitting

FAST FIT
PREMIUM FINISH*

MATRIX R15

An undermount sink provides a sleek, premium finish, but you're limited to timely, precision solid surface installations.

The Matrix R15 range allows for a low profile INSET installation to give the premium look with a considerably quicker installation time.

With no minimum fitting depth for an inset installation and everything included in the box this is your go-to sink for fast-fit installation.

Get the undermount look in half the time with the Matrix R15 offer.

Once the cut out is done when installing this product inset mounted, the install should take no longer than 15-20 minutes by using fast fit clips to position and secure the sink in place.

Using this inset installation method whilst maintaining a high end undermount look ticks all of the boxes for many of our customers.



Trend Focus

Abode offer an array of tap styles and functionality across their design leading portfolio, with many options available in an array of special finishes. We hope you find something that ticks all the boxes.



CHROME



BRUSHED NICKEL



GRAPHITE



MATT BLACK



STAINLESS STEEL

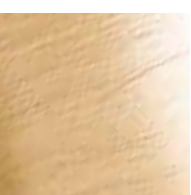

BRUSHED BRASS

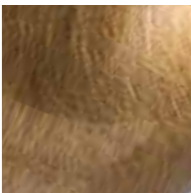

ANTIQUE BRASS

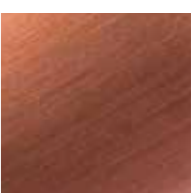

URBAN COPPER

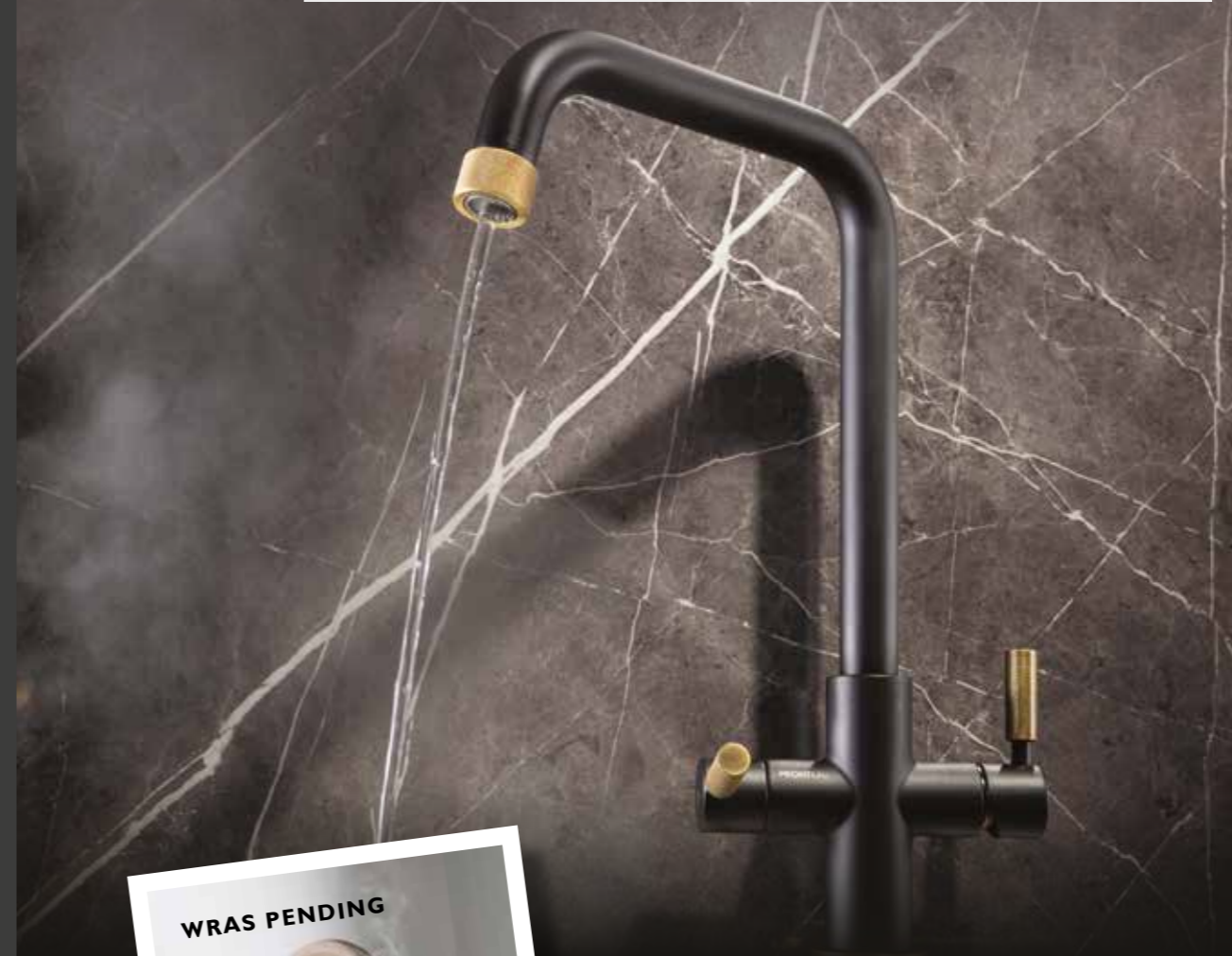

abode







Abode is a division of Norcros Group (Holdings) Limited.

Errors and omissions excepted.

Our policy is to continually improve and develop our products, and accordingly we reserve the right to amend specifications, particulars of weights, measures, prices, dimensions, finish and colour availability without prior notice.

abode

Unit L, Zenith Park,
Whaley Road,
Barnsley,
South Yorkshire
S75 1HT
Tel: 01226 283434
Email: contracts@abodedesigns.co.uk

 www.abodedesigns.co.uk  [Instagram.com/abode_home](https://www.instagram.com/abode_home)  [Pinterest.co.uk/AbodeDesigns](https://www.pinterest.co.uk/AbodeDesigns)
 [Facebook.com/abodehomeproducts](https://www.facebook.com/abodehomeproducts)  [Twitter.com/abodehome](https://www.twitter.com/abodehome)  [Abode YouTube channel](#)



January 2024